

## FEATURES

The W610 Series filter assembly can be manifold mounted to the hydraulic system. Other port options include SAE straight thread and 4 bolt flange. Western Filter's proprietary BetaPore™ 5 layer media is offered in a variety of Pak™ designs. Five different media grades are offered down to 5.1µ(c). Element core collapse options range from 150 to 3000 PSI. The differential pressure indicator line is designed to work with the wide assortment of bypass valves. Thermal lockout and surge control are two key features incorporated in many of the valves.

Western Filter elements are compatible with petroleum oils, water glycol, oil/water, HWCF and synthetic fluids.

### Technical Data:

Maximum Working Pressure	6000 psi (414 bar)
Fatigue Pressure Rating	3500 psi max (241 bar)
Typical Burst Pressure	20000 psi max (1379 bar)
Temperature Range	Operating
Buna N	-45°F to + 225°F (-43°C to + 107°C)
Viton	-20°F to + 250°F (-29°C to + 121°C)
Head Material	Cast Iron
Bowl Material	Steel
Weight (without elements)	
Assembly length 1	9.72 lbs. (4,4 kg.)
Assembly length 2	12.33 lbs. (5,6 kg.)
Assembly length 4	15.23 lbs. (6,89 kg.)

## W610

55 gpm (208 l/min)

Replacement elements available for C-Pak™ and H-Pak™ elements

Optional manifold mounting

Wide range of indicator options

Optional mounting bracket

High collapse H-Pak™ element available for use with non-bypass applications



## ACCESSORIES

Seal Kit -Buna N	P-427466-04
Seal Kit -E.P.R.	P-427466-05
Seal Kit -Viton	P-427466-06
Mounting Bracket	P-426225-01

### Housing and Filter Element

Flow versus Pressure Drop

150 SUS (32 cSt.) oil with specific gravity  $\leq 0.9$

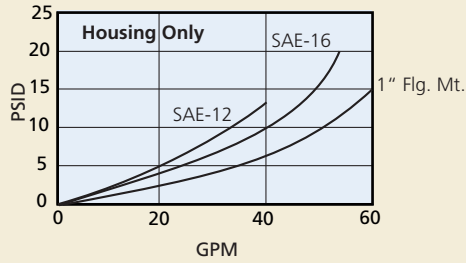

**Viscosity Correction Formula**

$$\Delta P \text{ Element} = \text{psid from catalog} \times \frac{\text{New Viscosity (SUS)}}{150} \times \frac{\text{New Specific Gravity}}{0.90}$$

$$\Delta P \text{ Housing} = \text{psid from catalog} \times \frac{\text{New Specific Gravity}}{0.90}$$

$$\Delta P \text{ Assembly} = \Delta P \text{ Element} + \Delta P \text{ Housing}$$

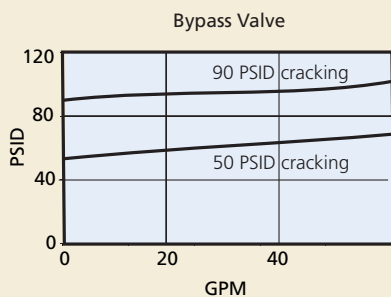
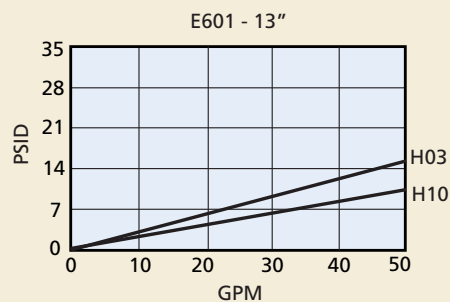
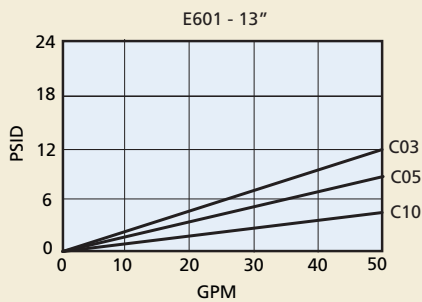
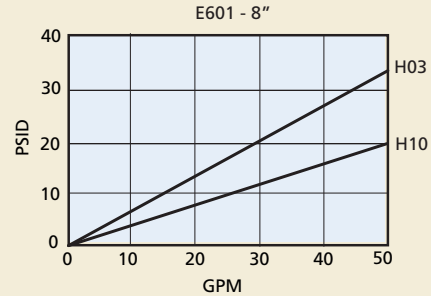
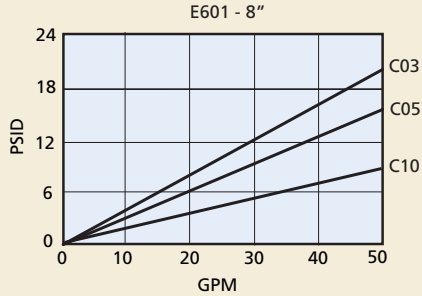
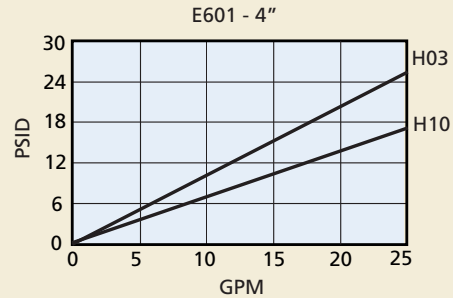
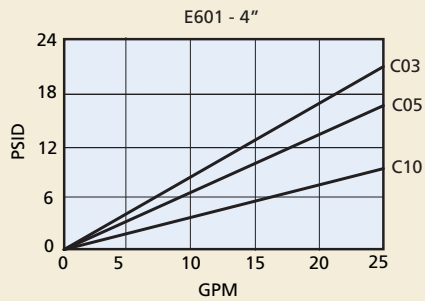

LOW PRESSURE  
SPIN-ON FILTERS

MEDIUM PRESSURE  
SPIN-ON FILTERS

IN-TANK FILTERS

LOW PRESSURE FILTERS

MEDIUM PRESSURE FILTERS

HIGH PRESSURE FILTERS

Filter Assembly	<b>W610</b> TABLE 1	<b>1</b> TABLE 2	<b>A</b> TABLE 3	<b>4</b> TABLE 4	<b>J   N</b> TABLE 5	<b>B</b> TABLE 6	<b>1</b> TABLE 7	<b>C</b> TABLE 8	<b>10</b> TABLE 9
Service Element	<b>E601</b> TABLE 1	<b>1</b> TABLE 2	<b>B</b> TABLE 6	<b>1</b> TABLE 7	<b>C</b> TABLE 8	<b>10</b> TABLE 9			

**Table 1**

Filter Assembly / Service Element	
CODE	DESCRIPTION
W610	Assembly
E601	Element

**Table 2**

Element Collapse Options	
CODE	DESCRIPTION
1	150 psid for housing w/bypass valve
4	3000 psi for housing w/o bypass valve (H-Pak™ only)

**Table 3**

Port Size Options	
CODE	PORT SIZE
A	1-1/16" - 12 UN (SAE 12)
B	1-5/16" - 12 UN (SAE 16)
F	1" SAE 4 Bolt Flange Code 61
M	1" SAE 4 Bolt Flange Code 62
S	Manifold Mounting

**Table 4**

Bypass Setting Options	
CODE	BYPASS SETTING
1	Non-bypass
4	50 psid
6	90 psid

**Note:** Use option 1 code only with 3000 psid collapse filter element.

**Table 5 (Primary)**

Indicator Style and Setting	
CODE	ΔP INDICATOR STYLE & SETTING
A	Visual indicator 70 psid w/TL and surge
B	Electrical/visual 70 psid w/TL and surge
D	Electrical/visual 35 psid
E	Electrical/visual 100 psid
G	Electrical/visual 35 psid w/TL
I	Visual indicator 70 psid
J	ΔP indicator plug
L	Visual indicator 35 psid
M	Visual indicator 35 psid w/ TL and surge
N	Electrical/visual 35 psid w/12" 3 wire flying lead
O	Visual indicator 100 psid
P	Visual indicator 100 psid w/TL and surge
R	Electrical switch 35 psid
S	Electrical/visual 100 psid w/12" 3-wire flying lead
T	Electrical switch 100 psid
U	Electrical switch 70 psid
V	Electrical/visual 70 psid w/TL
W	Electrical/visual 100 psid w/TL
Y	Electrical/visual 35 psid w/TL and surge
Z	Electrical/visual 100 psid w/TL and surge

TL (thermal lockout)

**Table 5 (Secondary)**

Receptacle Options	
CODE	ELECTRICAL STYLE
B	Brad Harrison (5-pin)
H	Hirschmann (4-pin)
N	None, for visual ΔP

**Table 6**

Seal Options	
CODE	MATERIAL
B	Buna N
E	E.P.R.
V	Viton

**Table 7**

Assembly & Element Length	
CODE (LGTH)	ELEMENT LENGTH
1 (6.75")	4.0"
2 (10.40")	8.0"
4 (14.03")	13.0"

**Table 8**

Element Code	
CODE	DESCRIPTION
C	(Glass) 03, 05, 10
H	(Glass) 03, 10

**Table 9**

Media Rating	
CODE	TARGET FLUID CLEANLINESS LEVEL
03	16/14/12 or better
05	18/16/14 or better
10	20/18/15 or better

*Note: Information concerning fluid cleanliness codes is on page 6, the Media Grade Selection Guide.*

**Metric Porting Available**

Change W610 to G610  
 Porting code A becomes G3/4" ISO 228 BSPP  
 Porting code B becomes G1" ISO 228 BSPP  
 Porting code F becomes 1" SAE 4 bolt flange with M10 mounting threads  
 Porting code M becomes 1" SAE 4 bolt flange with M12 mounting threads

Indicator Switch Schematic Wiring Diagram

Aluminum Electrical Housings

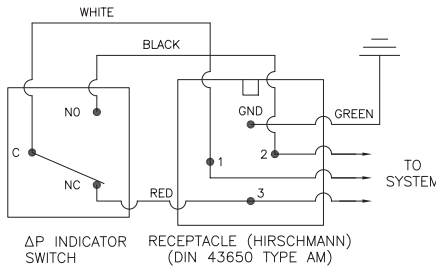
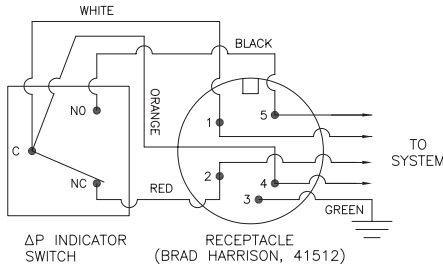

Note: The female plug (connector) is to be furnished by customer.

Plastic Electrical Housings

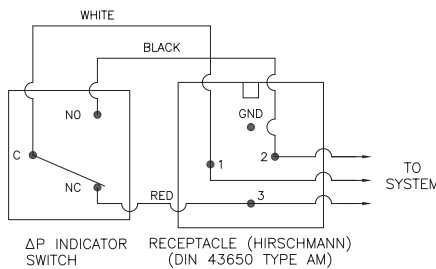
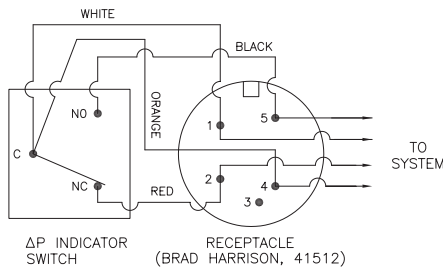

Note: The female plug (connector) is to be furnished by customer.

Dimensions:  
millimeters/(inches)

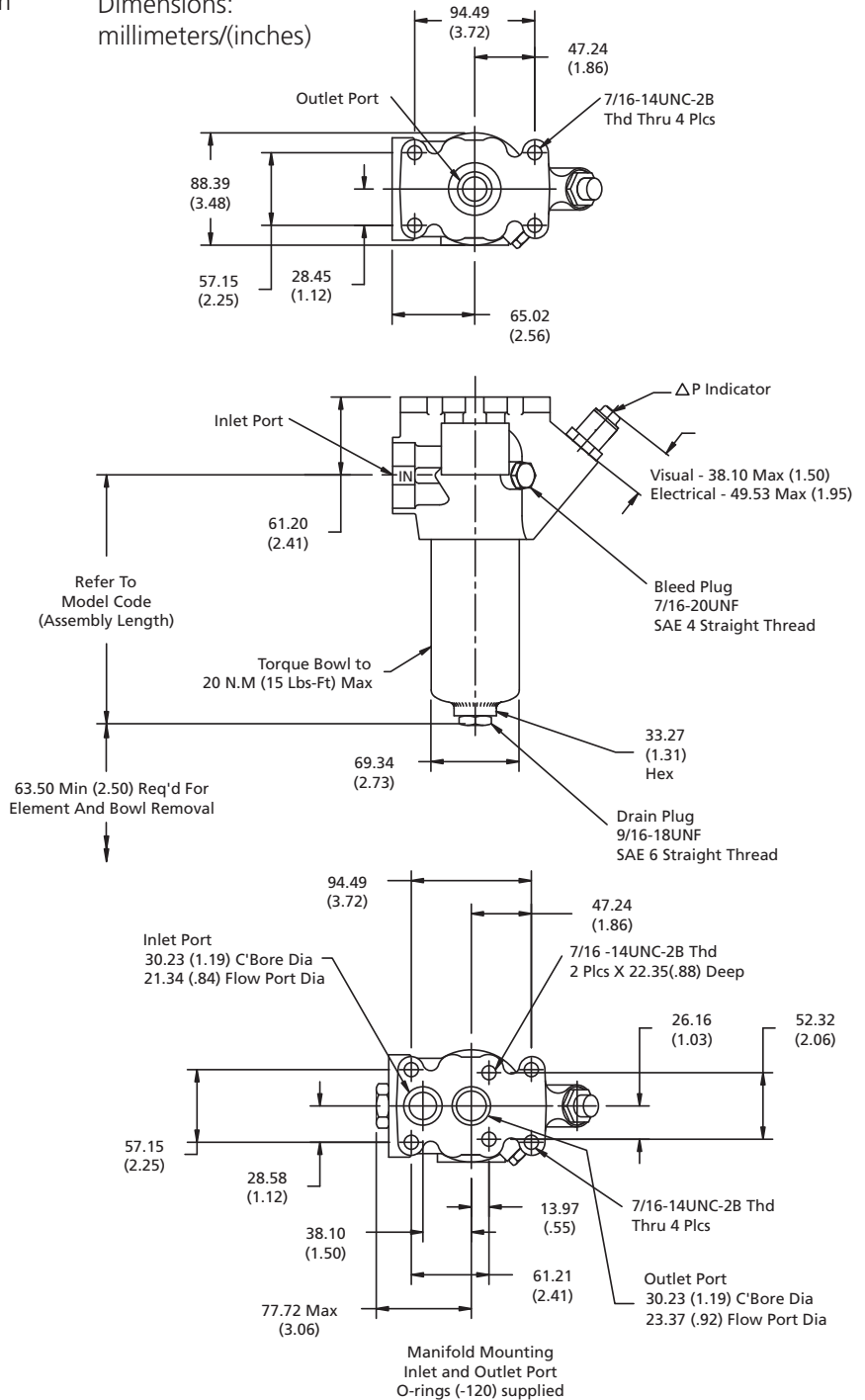

**Differential Indicators:** Indicators are designed to actuate at approximately 80% of bypass valve cracking pressure. It is recommended that an indicator with a bypass setting of 100 psid is used with a non-bypass housing.

**Surge Control:** This optional feature is used to dampen pressure surges or spikes to avoid premature actuation of the indicator. Surge control delays the indicator response.

**Thermal Lockout:** The Thermal Lockout prevents premature signaling of a bypass condition created by viscous fluid during cold start-ups. Normal indicator actuation capability is resumed once the operating temperature of the fluid reaches approximately 80 Deg. F.

## FEATURES

The WS610 Series filter is manifold mounted to the hydraulic system. This is a very practical design feature for direct mounting to machine tool manifolds. Western Filter's proprietary BetaPore™ 5 layer media is offered in a variety of Pak™ designs. Three media grades are offered down to 5.1μ(c). Element core collapse options range from 150 to 3000 PSI. The differential pressure indicator line is designed to work with the wide assortment of bypass valves. Thermal lockout and surge control are two key features incorporated in many of the valves.

Western Filter elements are compatible with petroleum oils, water glycol, oil/water, HWCF and synthetic fluids.

### Technical Data:

Maximum Working Pressure	6000 psi (414 bar)
Fatigue Pressure Rating	3200 psi max (221 bar)
Typical Burst Pressure	15,000 psi max (1034 bar)
Temperature Range	Operating
Buna N	-45°F to + 225°F (-43°C to + 107°C)
Viton	-20°F to + 250°F (-29°C to + 121°C)
Head Material	Cast Iron
Bowl Material	Steel
Weight (without elements)	
Assembly length 1	23 lbs. (10,4 kg.)
Assembly length 2	25 lbs. (11,3 kg.)
Assembly length 4	27.23 lbs. (12,3 kg.)

## WS610

55 gpm (208 l/min)

High collapse H-Pak™ element available for use with non-bypass applications

Diagnostic port in head for system analysis

Two bowl length options for design flexibility

Wide range of indicator options



## ACCESSORIES

Seal Kit -Buna N	P427466-07
Seal Kit -E.P.R.	P427466-08
Seal Kit -Viton	P427466-09

### Housing and Filter Element

Flow versus Pressure Drop

150 SUS (32 cSt.) oil with specific gravity ≤ 0.9

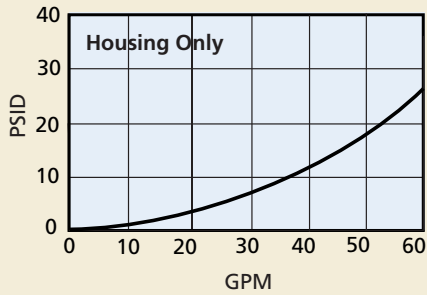

**Viscosity Correction Formula**

$$\Delta P \text{ Element} = \text{psid from catalog} \times \frac{\text{New Viscosity (SUS)}}{150} \times \frac{\text{New Specific Gravity}}{0.90}$$

$$\Delta P \text{ Housing} = \text{psid from catalog} \times \frac{\text{New Specific Gravity}}{0.90}$$

$$\Delta P \text{ Assembly} = \Delta P \text{ Element} + \Delta P \text{ Housing}$$

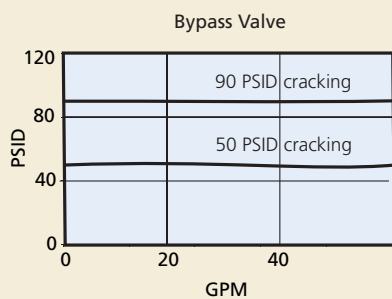
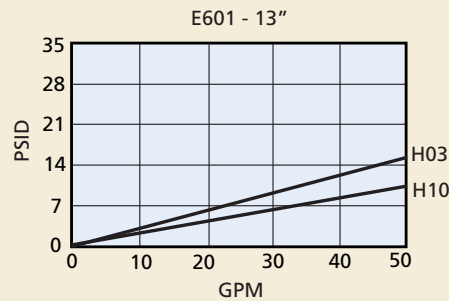
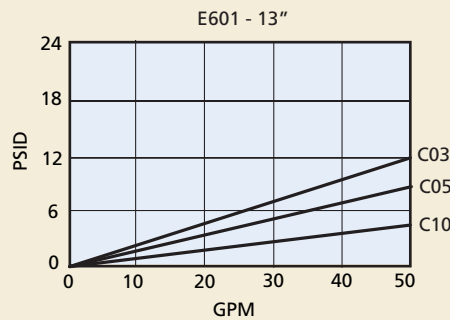
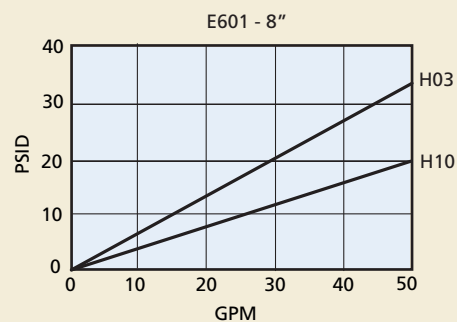
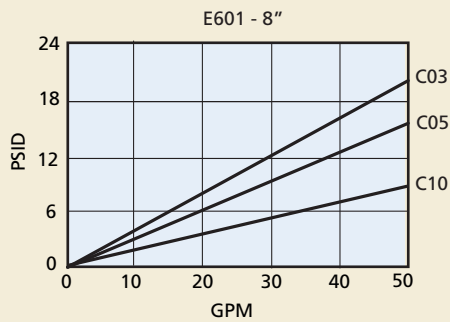
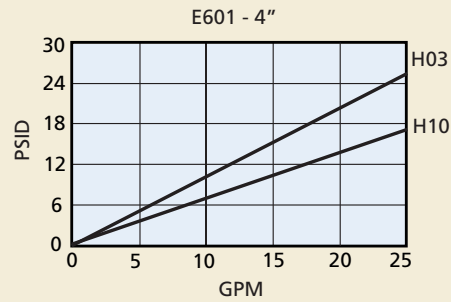
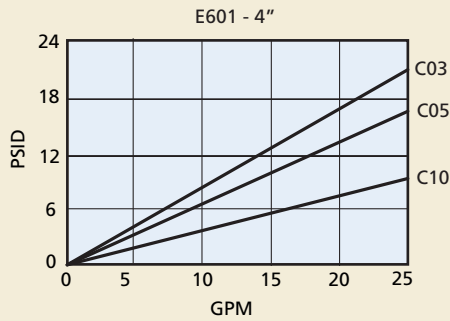

LOW PRESSURE  
SPIN-ON FILTERS

MEDIUM PRESSURE  
SPIN-ON FILTERS

IN-TANK FILTERS

LOW PRESSURE FILTERS

MEDIUM PRESSURE FILTERS

HIGH PRESSURE FILTERS

Filter Assembly	WS610	1	S	4	L   N	B	1	C	10
	TABLE 1	TABLE 2	TABLE 3	TABLE 4	TABLE 5	TABLE 6	TABLE 7	TABLE 8	TABLE 9
Service Element	E601	1	B	1	C	10			
	TABLE 1	TABLE 2	TABLE 6	TABLE 7	TABLE 8	TABLE 9			

**Table 1**

Filter Assembly / Service Element	
CODE	DESCRIPTION
WS610	Assembly
E601	Element

**Table 2**

Element Collapse Options	
CODE	DESCRIPTION
1	150 psid for housing w/bypass valve
4	3000 psi for housing w/o bypass valve (H-Pak™ only)

**Table 3**

Port Size Options	
CODE	PORT SIZE
S	Manifold Mounting

**Table 4**

Bypass Setting Options	
CODE	BYPASS SETTING
1	Non-bypass
4	50 psid
6	90 psid

**Note:** Use option 1 code only with 3000 psid collapse filter element.

**Table 5 (Primary)**

Indicator Style and Setting	
CODE	ΔP INDICATOR STYLE & SETTING
A	Visual indicator 70 psid w/TL and surge
B	Electrical/visual 70 psid w/TL and surge
D	Electrical/visual 35 psid
E	Electrical/visual 100 psid
G	Electrical/visual 35 psid w/TL
I	Visual indicator 70 psid
J	ΔP indicator plug
L	Visual indicator 35 psid
M	Visual indicator 35 psid w/ TL and surge
N	Electrical/visual 35 psid w/12" 3-wire flying lead
O	Visual indicator 100 psid
P	Visual indicator 100 psid w/TL and surge
R	Electrical switch 35 psid
S	Electrical/visual 100 psid w/12" 3-wire flying lead
T	Electrical switch 100 psid
U	Electrical switch 70 psid
V	Electrical/visual 70 psid w/TL
W	Electrical/visual 100 psid w/TL
Y	Electrical/visual 35 psid w/TL and surge
Z	Electrical/visual 100 psid w/TL and surge

TL (thermal lockout)

**Table 5 (Secondary)**

Receptacle Options	
CODE	ELECTRICAL STYLE
B	Brad Harrison (5-pin)
H	Hirschmann (4-pin)
N	None, for visual ΔP

**Table 6**

Seal Options	
CODE	MATERIAL
B	Buna N
E	E.P.R.
V	Viton

**Table 7**

Assembly & Element Length	
CODE (LGTH)	ELEMENT LENGTH
1 (10.9")	4.0"
2 (14.6")	8.0"
4 (18.2")	13.0"

**Table 8**

Element Code	
CODE	DESCRIPTION
C	(Glass) 03, 05, 10
H	(Glass) 03, 10

**Table 9**

Media Rating	
CODE	TARGET FLUID CLEANLINESS LEVEL
03	16/14/12 or better
05	18/16/14 or better
10	20/18/15 or better

*Note: Information concerning fluid cleanliness codes is on page 6, the Media Grade Selection Guide.*

Indicator Switch Schematic Wiring Diagram

Aluminum Electrical Housings

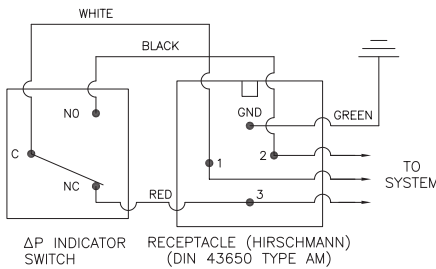
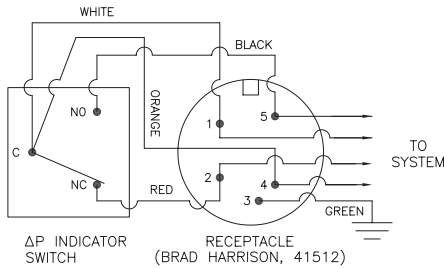

Note: The female plug (connector) is to be furnished by customer.

Plastic Electrical Housings

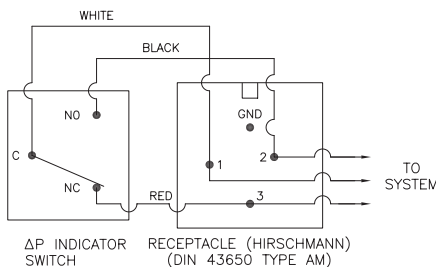
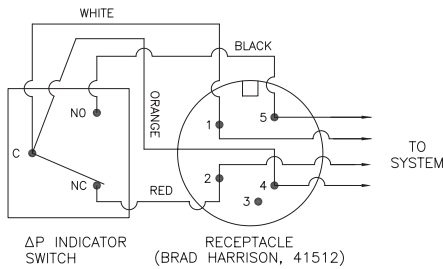

Note: The female plug (connector) is to be furnished by customer.

Dimensions:  
millimeters/(inches)

7/8-9UNC x 63.50(2.50)  
Long Grade 8 Bolts  
For 30.48(1.20) Engagement  
are Recommended,  
4 Req'd. Torque  
to 250-270N.M  
(185-250 Lbs-Ft)

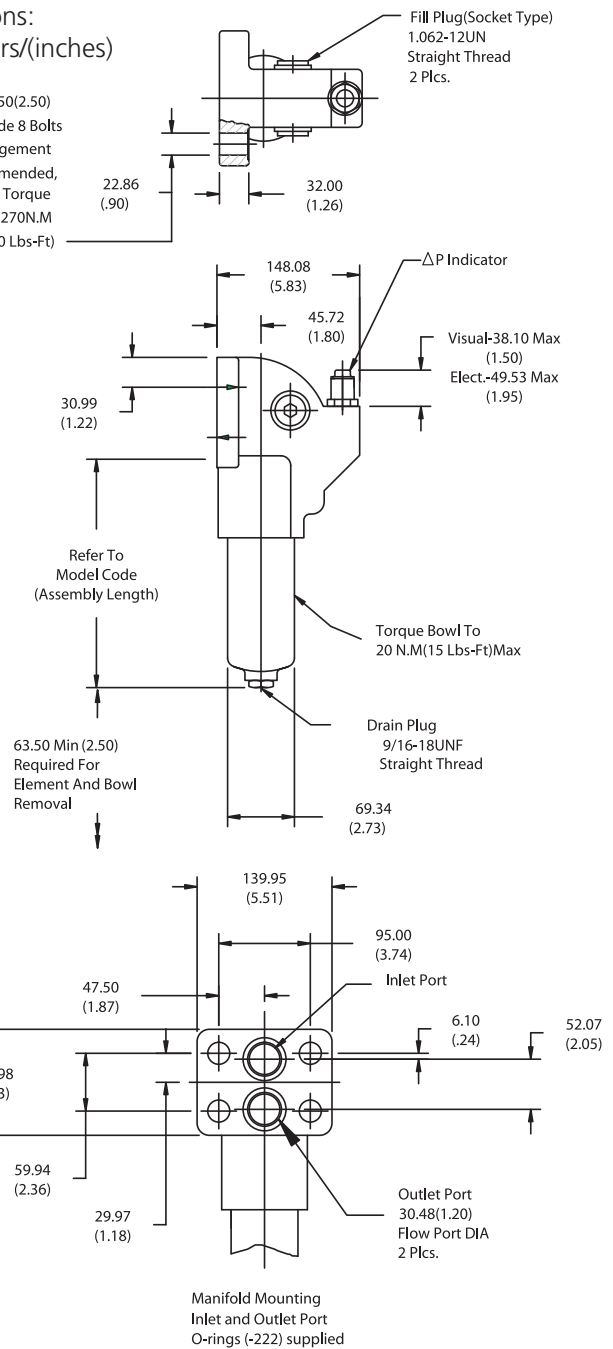

**Differential Indicators:** Indicators are designed to actuate at approximately 80% of bypass valve cracking pressure. It is recommended that an indicator with a bypass setting of 100 psid is used with a non-bypass housing.

**Surge Control:** This optional feature is used to dampen pressure surges or spikes to avoid premature actuation of the indicator. Surge control delays the indicator response.

**Thermal Lockout:** The Thermal Lockout prevents premature signaling of a bypass condition created by viscous fluid during cold start-ups. Normal indicator actuation capability is resumed once the operating temperature of the fluid reaches approximately 80 Deg. F.

## FEATURES

Use our W613 T-Type port arrangement as an alternative to our popular L-Type porting. These units are offered with the same bowl, element and indicators used in our W610 and WS610 series filters. Western Filter's proprietary BetaPore™ 5 layer media is offered in a variety of Pak™ designs. Three media grades are offered down to 5.1µ(c). Element core collapse options range from 150 to 3000 PSI. The differential pressure indicator line is designed to work with the wide assortment of bypass valves. Thermal lockout and surge control are two key features incorporated in many of the valves.

Western Filter elements are compatible with petroleum oils, water glycol, oil/water, HWCF and synthetic fluids.

### Technical Data:

Maximum Working Pressure	6500 psi (448 bar)
Fatigue Pressure Rating	3250 psi max (224 bar)
Typical Burst Pressure	20000 psi max (1380 bar)
Temperature Range	Operating
Buna N	-45°F to + 225°F (-43°C to + 107°C)
Viton	-20°F to + 250°F (-29°C to + 121°C)
Head Material	Cast Iron
Bowl Material	Steel
Weight (without elements)	
Assembly length 1	19.4 lbs. (8,8 kg.)
Assembly length 2	21.5 lbs. (9,8 kg.)

## W613

35 gpm (132 l/min)

Replacement elements available for H-Pak™ and C-Pak™

Optional bracket

Wide range of indicator options



## ACCESSORIES

Seal Kit -Buna N	P-238970-01
Seal Kit -E.P.R.	P-238970-02
Seal Kit -Viton	P-238970-03
Mounting Bracket	P-426225-01

**Housing and Filter Element**

Flow versus Pressure Drop

150 SUS (32 cSt.) oil with specific gravity  $\leq 0.9$

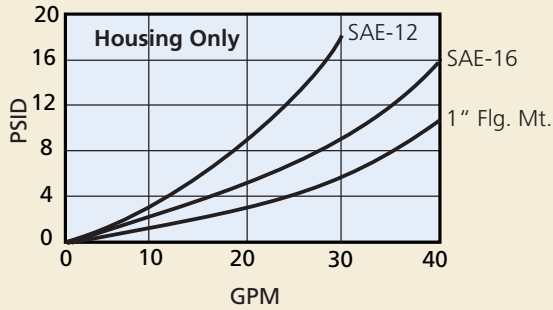

**Viscosity Correction Formula**

$$\Delta P \text{ Element} = \text{psid from catalog} \times \frac{\text{New Viscosity (SUS)}}{150} \times \frac{\text{New Specific Gravity}}{0.90}$$

$$\Delta P \text{ Housing} = \text{psid from catalog} \times \frac{\text{New Specific Gravity}}{0.90}$$

$$\Delta P \text{ Assembly} = \Delta P \text{ Element} + \Delta P \text{ Housing}$$

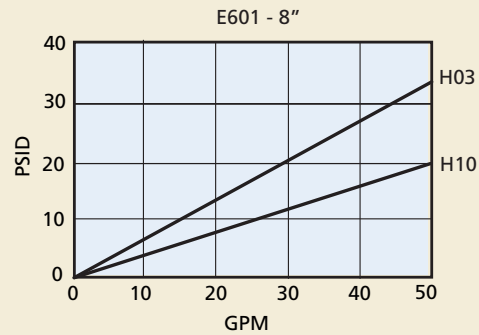
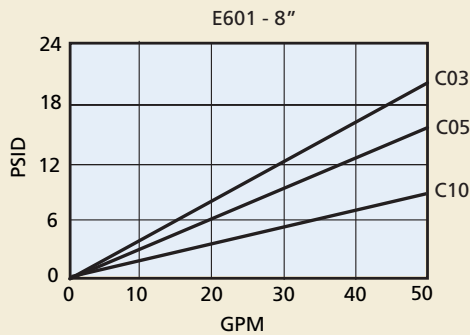
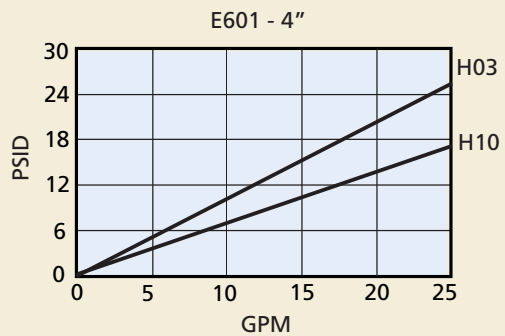
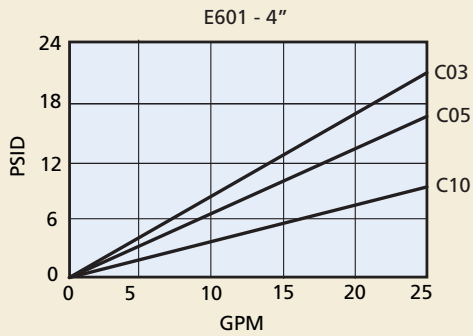

LOW PRESSURE SPIN-ON FILTERS

MEDIUM PRESSURE SPIN-ON FILTERS

IN-TANK FILTERS

LOW PRESSURE FILTERS

MEDIUM PRESSURE FILTERS

HIGH PRESSURE FILTERS

Filter Assembly	<b>W613</b> TABLE 1	<b>1</b> TABLE 2	<b>B</b> TABLE 3	<b>4</b> TABLE 4	<b>M N</b> TABLE 5	<b>B</b> TABLE 6	<b>2</b> TABLE 7	<b>C</b> TABLE 8	<b>10</b> TABLE 9
Service Element	<b>E601</b> TABLE 1	<b>1</b> TABLE 2	<b>B</b> TABLE 6	<b>2</b> TABLE 7	<b>C</b> TABLE 8	<b>10</b> TABLE 9			

 Order model code **W6131B4MNB2C10** for same day shipment.

**Table 1**

Filter Assembly / Service Element	
CODE	DESCRIPTION
W613	Assembly
E601	Element

**Table 2**

Element Collapse Options	
CODE	DESCRIPTION
1	150 psid for housing w/bypass valve
4	3000 psi for housing w/o bypass valve (H-Pak™ only)

**Table 3**

Port Size Options	
CODE	PORT SIZE
A	1-1/16" - 12 UN (SAE 12)
B	1-5/16" - 12 UN (SAE 16)
F	1" SAE 4 Bolt Flange Code 61
M	1" SAE 4 Bolt Flange Code 62

**Table 4**

Bypass Setting Options	
CODE	BYPASS SETTING
1	Non-bypass
4	50 psid
6	90 psid

**Note:** Use option 1 code only with 3000 psid collapse filter element.

**Table 5 (Primary)**

Indicator Style and Setting	
CODE	ΔP INDICATOR STYLE & SETTING
A	Visual indicator 70 ± 10 psid w/TL and surge
B	Electrical/visual 70 ± 10 psid w/TL and surge
D	Electrical/visual 35 ± 5 psid
E	Electrical/visual 100 ± 12 psid
G	Electrical/visual 35 ± 5 psid w/TL
I	Visual indicator 70 ± 10 psid
J	No indicator
L	Visual indicator 35 ± 5 psid
M	Visual indicator 35 ± 5 psid w/ TL and surge
N	Electrical/visual 35 ± 5 psid w/12" 3 wire flying lead
O	Visual indicator 100 ± 12 psid
P	Visual indicator 100 ± 12 psid w/TL and surge
R	Electrical switch 35 ± 5 psid
S	Electrical/visual 100 ± 12 psid w/12" 3 wire flying lead
T	Electrical switch 100 ± 12 psid
U	Electrical switch 70 ± 10 psid
V	Electrical/visual 70 ± 10 psid w/TL
W	Electrical/visual 100 ± 12 psid w/TL
Y	Electrical/visual 35 ± 5 psid w/TL and surge
Z	Electrical/visual 100 ± 12 psid w/TL and surge

TL (thermal lockout)

**Table 5 (Secondary)**

Receptacle Options	
CODE	ELECTRICAL STYLE
B	Brad Harrison (5-pin)
H	Hirschmann (4-pin)
N	None, for visual ΔP

**Table 6**

Seal Options	
CODE	MATERIAL
B	Buna N
E	E.P.R.
V	Viton

**Table 7**

Assembly & Element Length	
CODE (LGTH)	ELEMENT LENGTH
1 (8.10")	4.0"
2 (11.75")	8.0"
4 (18.2")	13.0"

**Table 8**

Element Code	
CODE	DESCRIPTION
C	(Glass) 03, 05, 10
H	(Glass) 03, 10

**Table 9**

Media Rating	
CODE	TARGET FLUID CLEANLINESS LEVEL
03	16/14/12 or better
05	18/16/14 or better
10	20/18/15 or better

*Note: Information concerning fluid cleanliness codes is on page 6, the Media Grade Selection Guide.*

**Metric Porting Available**

Change W613 to G613  
 Porting code A becomes 3/4" ISO 228 BSPP  
 Porting code B becomes 1" ISO 228 BSPP  
 Porting code F becomes 1" SAE 4 bolt flange with M10 mounting threads  
 Porting code M becomes 1" SAE 4 bolt flange with M12 mounting threads

Indicator Switch Schematic Wiring Diagram

Aluminum Electrical Housings

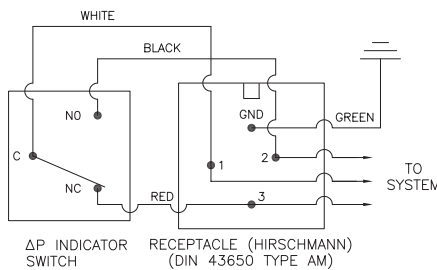
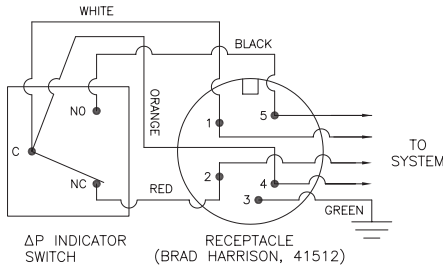

Note: The female plug (connector) is to be furnished by customer.

Plastic Electrical Housings

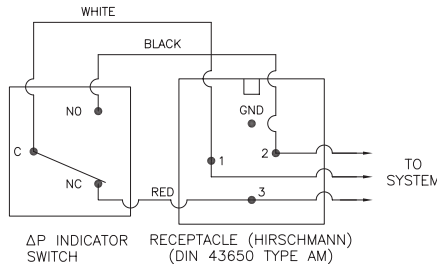
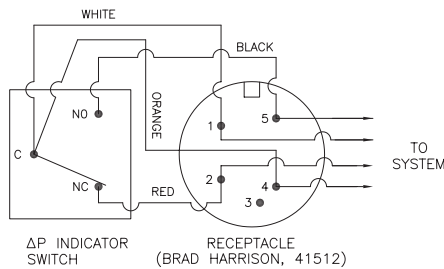

Note: The female plug (connector) is to be furnished by customer.

Dimensions:  
millimeters/(inches)

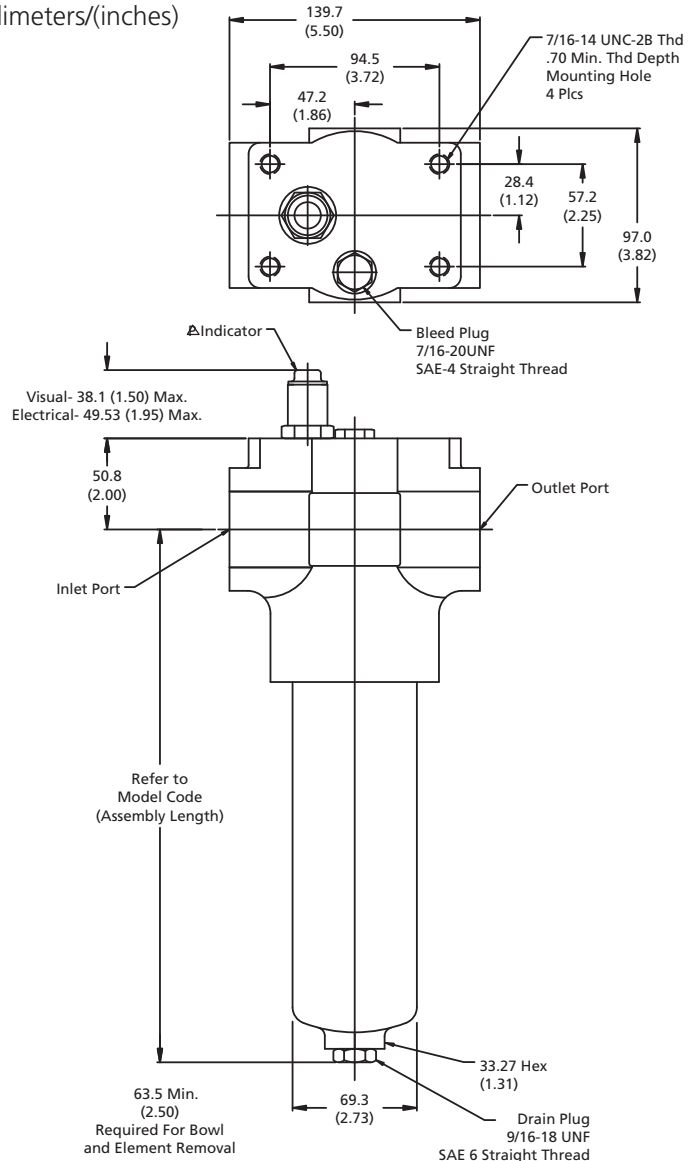

**Differential Indicators:** Indicators are designed to actuate at approximately 80% of bypass valve cracking pressure. It is recommended that an indicator with a bypass setting of 100 psid is used with a non-bypass housing.

**Surge Control:** This optional feature is used to dampen pressure surges or spikes to avoid premature actuation of the indicator. Surge control delays the indicator response.

**Thermal Lockout:** The Thermal Lockout prevents premature signaling of a bypass condition created by viscous fluid during cold start-ups. Normal indicator actuation capability is resumed once the operating temperature of the fluid reaches approximately 80 Deg. F.

LOW PRESSURE SPIN-ON FILTERS

MEDIUM PRESSURE SPIN-ON FILTERS

IN-TANK FILTERS

LOW PRESSURE FILTERS

MEDIUM PRESSURE FILTERS

HIGH PRESSURE FILTERS

## FEATURES

Filter assembly W620 contains the popular HF3 filter element. The HF3 (E6021 series element) is offered throughout the product line. Western Filter's proprietary BetaPore™ 5 layer media is offered in a variety of Pak™ constructions. Five different media grades are offered down to 4.0µ(c). Element core collapse options range from 150 to 3000 PSI. Several reverse flow options are offered with our integrated valve options. The differential pressure indicator line is designed to work with the wide assortment of bypass valves. Thermal lockout and surge control are two key features incorporated in many of the valves.

Western Filter elements are compatible with petroleum oils, water glycol, oil-water, HWCF and synthetic fluids.

### Technical Data:

Maximum Working Pressure	6000 psi (414 bar)
Fatigue Pressure Rating	3000 psi max (207 bar)
Typical Burst Pressure	15000 psi max (1034 bar)
Temperature Range	Operating
Buna N	-45°F to + 225°F (-43°C to + 107°C)
Viton	-20°F to + 250°F (-29°C to + 121°C)
Head Material	Cast Iron
Bowl Material	Steel
Weight (without elements)	
Assembly length 1	19.80 lbs. (8,9 kg.)
Assembly length 2	24.30 lbs. (11,0 kg.)
Assembly length 4	29.70 lbs. (13,4 kg.)
Assembly length 5	39.78 lbs. (18,0 kg.)

## W620

150 gpm (568 l/min)

Conforms to HF3 specifications

High collapse H-Pak™ element available for use with non-bypass applications

Reverse flow bypass valve option available for hydrostatic applications

Accepts coreless elements with removable coretube

Wide range of indicator options

Flexible mounting capability with optional mounting brackets



## ACCESSORIES

Seal Kit -Buna N	P-427466-10
Seal Kit -E.P.R.	P-427466-11
Seal Kit -Viton	P-427466-12
Mounting Bracket	P-426218-01
Core Tube Assembly-Code Length-1	PW620R1BN
Core Tube Assembly-Code Length-2	PW620R2BN
Core Tube Assembly-Code Length-4	PW620R4BN
Core Tube Assembly-Code Length-5	PW620R5BN

### Housing and Filter Element

Flow versus Pressure Drop

150 SUS (32 cSt.) oil with specific gravity  $\leq 0.9$

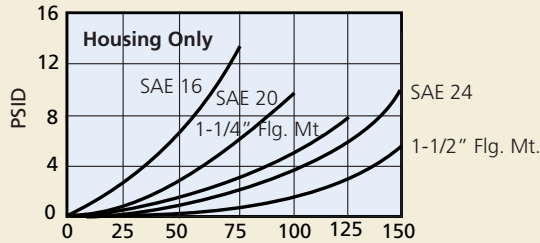

**Viscosity Correction Formula**

$$\Delta P \text{ Element} = \text{psid from catalog} \times \frac{\text{New Viscosity (SUS)}}{150} \times \frac{\text{New Specific Gravity}}{0.90}$$

$$\Delta P \text{ Housing} = \text{psid from catalog} \times \frac{\text{New Specific Gravity}}{0.90}$$

$$\Delta P \text{ Assembly} = \Delta P \text{ Element} + \Delta P \text{ Housing}$$

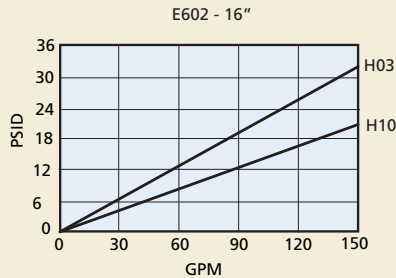
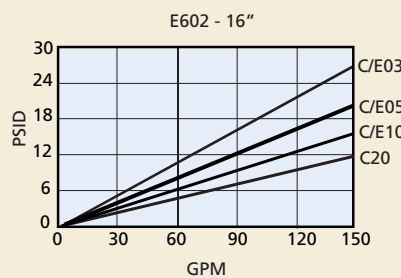
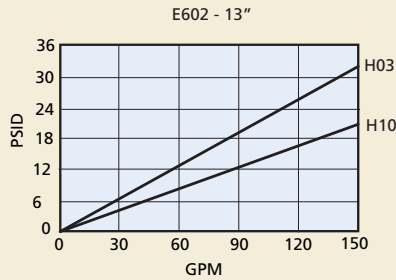
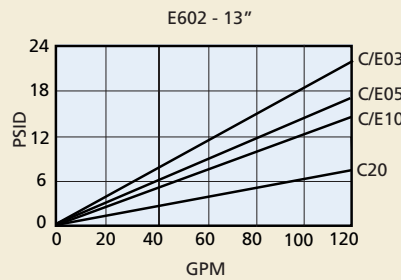
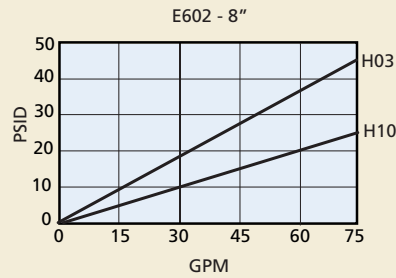
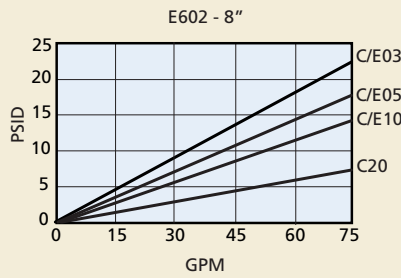
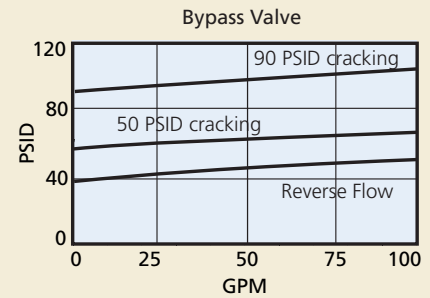
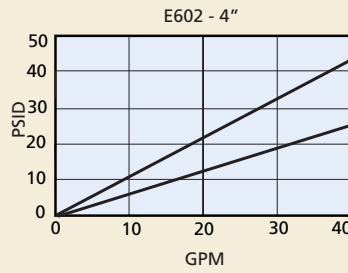
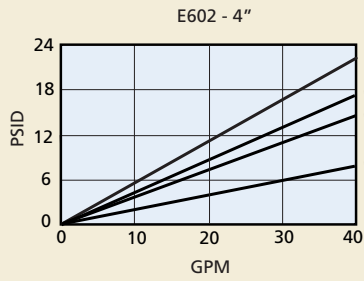

LOW PRESSURE  
SPIN-ON FILTERS

MEDIUM PRESSURE  
SPIN-ON FILTERS

IN-TANK FILTERS

LOW PRESSURE FILTERS

MEDIUM PRESSURE FILTERS

HIGH PRESSURE FILTERS

Filter Assembly	<b>W620</b> TABLE 1	<b>1</b> TABLE 2	<b>B</b> TABLE 3	<b>4</b> TABLE 4	<b>L N</b> TABLE 5	<b>B</b> TABLE 6	<b>2</b> TABLE 7	<b>C</b> TABLE 8	<b>10</b> TABLE 9
Service Element	<b>E602</b> TABLE 1	<b>1</b> TABLE 2	<b>B</b> TABLE 6	<b>2</b> TABLE 7	<b>C</b> TABLE 8	<b>10</b> TABLE 9			

**Table 1**

Filter Assembly / Service Element	
CODE	DESCRIPTION
W620	Assembly
E602	Element

**Table 2**

Element Collapse Options	
CODE	DESCRIPTION
1	150 psid for housing w/bypass valve
4	3000 psi for housing w/o bypass valve (H-Pak™ only)

**Note:** E-Pak™ elements rated at 100 psid collapse. If used in non-bypass housing, a differential pressure indicator (70 psid max.) should be used.

**Table 3**

Port Size Options	
CODE	PORT SIZE
B	1-5/16" - 12 UN (SAE 16)
C	1-5/8" - 12 UN (SAE 20)
D	1-7/8" - 12 UN (SAE 24)
E	1-1/2" 4 Bolt Flange Code 61
G	1-1/4" 4 Bolt Flange Code 61
Q	1-1/4" 4 Bolt Flange Code 62

**Table 4**

Bypass Setting Options	
CODE	BYPASS SETTING
1	Non-bypass
4	50 psid
6	90 psid
7	90 psid w/reverse flow valve
8	Non-bypass w/reverse flow valve
9	50 psid w/reverse flow valve

**Note:** Use option 1 & 8 only with 3000 psid collapse filter element.

**Table 5 (Primary)**

Indicator Style and Setting	
CODE	ΔP INDICATOR STYLE & SETTING
A	Visual indicator 70 psid w/TL & surge
B	Electrical/visual 70 psid w/TL & surge
D	Electrical/visual 35 psid
E	Electrical/visual 100 psid
G	Electrical/visual 35 psid w/TL
I	Visual indicator 70 psid
J	ΔP indicator plug
L	Visual indicator 35 psid
M	Visual indicator 35 psid w/ TL and surge
N	Electrical/visual 35 psid w/12" 3 wire flying lead
O	Visual indicator 100 psid
P	Visual indicator 100 psid w/TL and surge
R	Electrical switch 35 psid
S	Electrical/visual 100 psid w/12" 3 wire flying lead
T	Electrical switch 100 psid
U	Electrical switch 70 psid
V	Electrical/visual 70 psid w/TL
W	Electrical/visual 100 psid w/TL
Y	Electrical/visual 35 psid w/TL and surge
Z	Electrical/visual 100 psid w/TL and surge

TL (thermal lockout)

**Table 5 (Secondary)**

Receptacle Options	
CODE	ELECTRICAL STYLE
B	Brad Harrison (5-pin)
H	Hirschmann (4-pin)
N	None, for visual ΔP indicator

**Table 6**

Seal Options	
CODE	MATERIAL
B	Buna N
E	E.P.R.
V	Viton

**Table 7**

Assembly & Element Length	
CODE (LGTH)	ELEMENT LENGTH
1 (9.0")	4.0"
2 (13.0")*	8.0"*
4 (18.0")	13.0"
5 (22.0")	16.0"

\*HF3

**Table 8**

Element Code	
CODE	DESCRIPTION
C	(Glass) 01, 03, 05, 10, 20
E	(Coreless) 01, 03, 05, 10
H	(Glass) 03, 10

**Table 9**

Media Rating	
CODE	TARGET FLUID CLEANLINESS LEVEL
01	Flushing only
03	16/14/12 or better
05	18/16/14 or better
10	20/18/15 or better
20	22/19/16 or better

*Note: Information concerning fluid cleanliness codes is on page 6, the Media Grade Selection Guide.*

**Metric Porting Available**

Change W620 to G620  
 Porting code B becomes 1" ISO 228 BSP  
 Porting code C becomes 1-1/4" ISO 228 BSP  
 Porting code D becomes 1-1/2" ISO 228 BSP  
 Porting code E becomes 1-1/2" SAE 4 bolt flange with M12 mounting threads  
 Porting code G becomes 1-1/4" SAE 4 bolt flange with M10 mounting threads  
 Porting code Q becomes 1-1/4" SAE 4 bolt flange with M14 mounting threads

Indicator Switch Schematic Wiring Diagram

Aluminum Electrical Housings

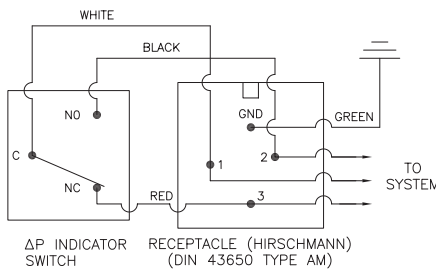
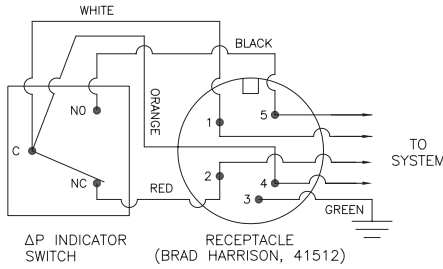

Note: The female plug (connector) is to be furnished by customer.

Plastic Electrical Housings

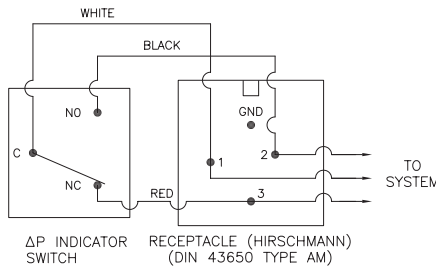
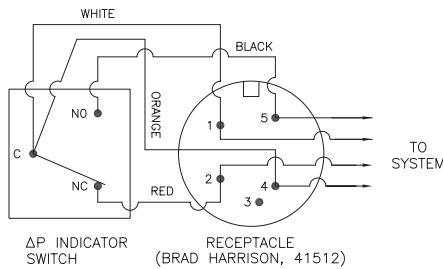

Note: The female plug (connector) is to be furnished by customer.

Dimensions:  
millimeters/(inches)

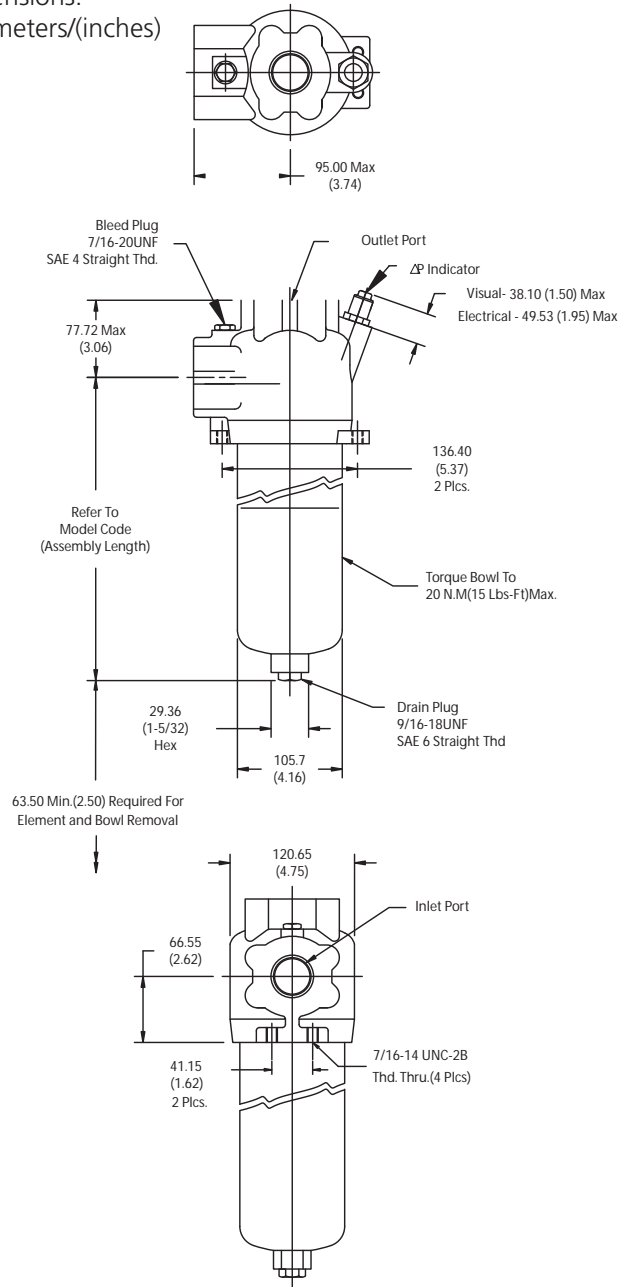

**Differential Indicators:** Indicators are designed to actuate at approximately 80% of bypass valve cracking pressure. It is recommended that an indicator with a bypass setting of 100 psid is used with a non-bypass housing.

**Surge Control:** This optional feature is used to dampen pressure surges or spikes to avoid premature actuation of the indicator. Surge control delays the indicator response.

**Thermal Lockout:** The Thermal Lockout prevents premature signaling of a bypass condition created by viscous fluid during cold start-ups. Normal indicator actuation capability is resumed once the operating temperature of the fluid reaches approximately 80 Deg. F.

## FEATURES

Filter assembly WS620 is manufactured to meet the HF3 automotive standard. The HF3 element (E6021) series is offered throughout the product line. Working pressure up to 6000 psi combined with a choice of 4 bowl lengths, offer a wide range of flows and dirt holding capabilities. The flange mounted design is an ideal choice for direct mounting to the hydraulic system. The rugged cast iron head and steel bowl design are required to meet today's high pressure system demands. Our standard bowl drain plug helps relieve system pressure during filter change outs. Western Filter's proprietary BetaPore™ 5 layer media is offered in a variety of Pak™ constructions. Five different media grades are offered down to 4.0µ(c).

Western Filter elements are compatible with petroleum oils, water glycol, oil/water, HWCF and synthetic fluids.

### Technical Data:

Maximum Working Pressure	6000 psi (414 bar)
Fatigue Pressure Rating	3000 psi max (207 bar)
Typical Burst Pressure	15000 psi max (1034 bar)
Temperature Range	Operating
Buna N	-45°F to + 225°F (-43°C to + 107°C)
Viton	-20°F to + 250°F (-29°C to + 121°C)
Head Material	Cast Iron
Bowl Material	Steel
Weight (without elements)	
Assembly length 1	25 lbs. (11,4 kg.)
Assembly length 2	27 lbs. (12,3 kg.)
Assembly length 4	29 lbs. (13,2 kg.)
Assembly length 5	33 lbs. (15,1 kg.)

## WS620

150 gpm (568 l/min)

Conforms to HF3 specifications

Replacement element available in C-Pak™ or H-Pak™ media

Accepts coreless elements with removable coretube

Wide range of indicator options

Four bowl length options for design flexibility



## ACCESSORIES

Seal Kit -Buna N	P-427466-13
Seal Kit -E.P.R.	P-427466-14
Seal Kit -Viton	P-427466-15
Mounting Bracket	P-426218-01
Core Tube Assembly-Code Length-1	PW620R1BN
Core Tube Assembly-Code Length-2	PW620R2BN
Core Tube Assembly-Code Length-4	PW620R4BN
Core Tube Assembly-Code Length-5	PW620R5BN

### Housing and Filter Element

Flow versus Pressure Drop

150 SUS (32 cSt.) oil with specific gravity  $\leq 0.9$

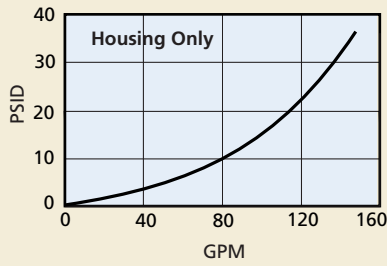

**Viscosity Correction Formula**

$$\Delta P \text{ Element} = \text{psid from catalog} \times \frac{\text{New Viscosity (SUS)}}{150} \times \frac{\text{New Specific Gravity}}{0.90}$$

$$\Delta P \text{ Housing} = \text{psid from catalog} \times \frac{\text{New Specific Gravity}}{0.90}$$

$$\Delta P \text{ Assembly} = \Delta P \text{ Element} + \Delta P \text{ Housing}$$

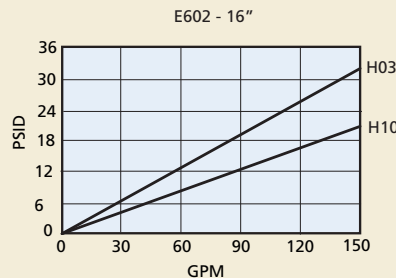
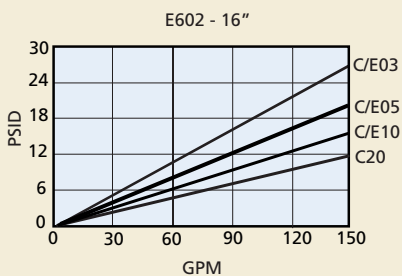
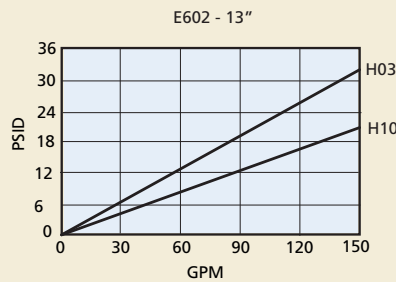
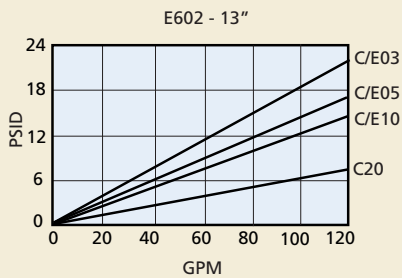
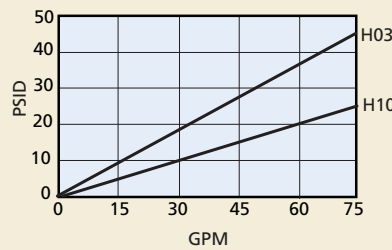
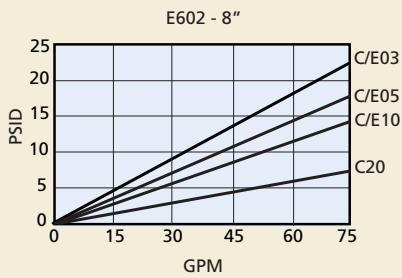
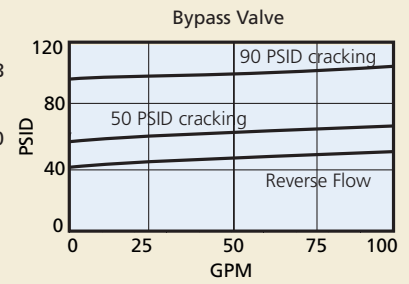
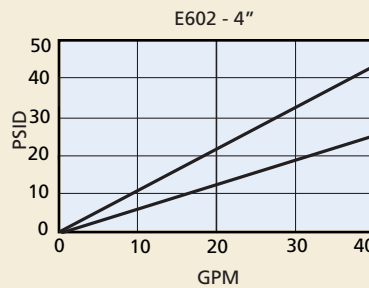
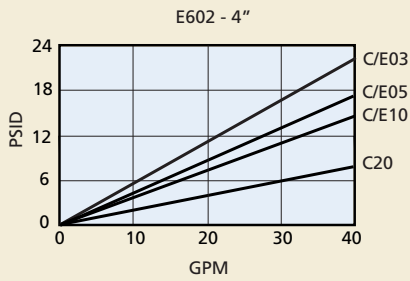

LOW PRESSURE SPIN-ON FILTERS

MEDIUM PRESSURE SPIN-ON FILTERS

IN-TANK FILTERS

LOW PRESSURE FILTERS

MEDIUM PRESSURE FILTERS

HIGH PRESSURE FILTERS

Filter Assembly	WS620 TABLE 1	1 TABLE 2	S TABLE 3	4 TABLE 4	D   H TABLE 5	B TABLE 6	2 TABLE 7	C TABLE 8	10 TABLE 9
-----------------	------------------	--------------	--------------	--------------	------------------	--------------	--------------	--------------	---------------

Service Element	E602 TABLE 1	1 TABLE 2	B TABLE 6	2 TABLE 7	C TABLE 8	10 TABLE 9
-----------------	-----------------	--------------	--------------	--------------	--------------	---------------

**Table 1**

Filter Assembly / Service Element	
CODE	DESCRIPTION
WS620	Assembly
E602	Element

**Table 2**

Element Collapse Options	
CODE	DESCRIPTION
1	150 psid for housing w/bypass valve
4	3000 psi for housing w/o bypass valve (H-Pak™ only)

**Note:** E-Pak™ elements rated at 100 psid collapse. If used in non-bypass housing, a differential pressure indicator (70 psid max.) should be used.

**Table 3**

Port Size Options	
CODE	PORT SIZE
S	Manifold Mounting

**Table 4**

Bypass Setting Options	
CODE	BYPASS SETTING
1	Non-bypass
4	50 psid
6	90 psid
7	90 psid w/reverse flow valve
8	Non-bypass w/reverse flow valve
9	50 psid w/reverse flow valve

**Note:** Use option 1 & 8 only with 3000 psid collapse filter element.

**Table 5 (Primary)**

Indicator Style and Setting	
CODE	ΔP INDICATOR STYLE & SETTING
A	Visual indicator 70 psid w/TL and surge
B	Electrical/visual 70 psid w/TL and surge
D	Electrical/visual 35 psid
E	Electrical/visual 100 psid
G	Electrical/visual 35 psid w/TL
I	Visual indicator 70 psid
J	ΔP indicator plug
L	Visual indicator 35 psid
M	Visual indicator 35 psid w/ TL and surge
N	Electrical/visual 35 psid w/12" 3-wire flying lead
O	Visual indicator 100 psid
P	Visual indicator 100 psid w/TL and surge
R	Electrical switch 35 psid
S	Electrical/visual 100 psid w/12" 3-wire flying lead
T	Electrical switch 100 psid
U	Electrical switch 70 psid
V	Electrical/visual 70 psid w/TL
W	Electrical/visual 100 psid w/TL
Y	Electrical/visual 35 psid w/TL and surge
Z	Electrical/visual 100 psid w/TL and surge

TL (thermal lockout)

**Table 5 (Secondary)**

Receptacle Options	
CODE	ELECTRICAL STYLE
B	Brad Harrison (5-pin)
H	Hirschmann (4-pin)
N	None, for visual ΔP

**Table 6**

Seal Options	
CODE	MATERIAL
B	Buna N
E	E.P.R.
V	Viton

**Table 7**

Assembly & Element Length	
CODE (LGTH)	ELEMENT LENGTH
1 (11.8")	4.0"
2 (15.5")*	8.0"*
4 (20.2")	13.0"
5 (24.1")	16.0"

\*HF3

**Table 8**

Element Code	
CODE	DESCRIPTION
C	(Glass) 01, 03, 05, 10, 20
E	(Coreless) 01, 03, 05, 10
H	(Glass) 03, 10

**Table 9**

Media Rating	
CODE	TARGET FLUID CLEANLINESS LEVEL
01	Flushing only
03	16/14/12 or better
05	18/16/14 or better
10	20/18/15 or better
20	22/19/16 or better

*Note: Information concerning fluid cleanliness codes is on page 6, the Media Grade Selection Guide.*

Indicator Switch Schematic Wiring Diagram

Aluminum Electrical Housings

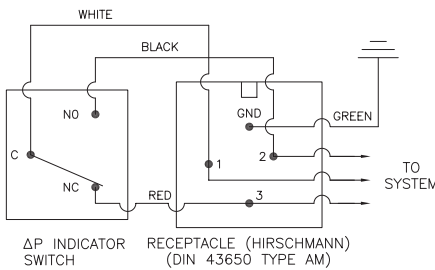
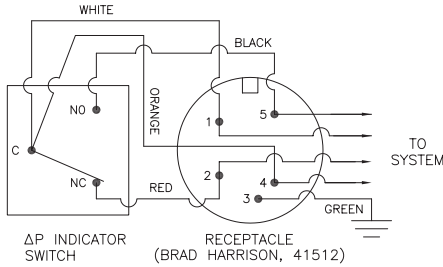

Note: The female plug (connector) is to be furnished by customer.

Plastic Electrical Housings

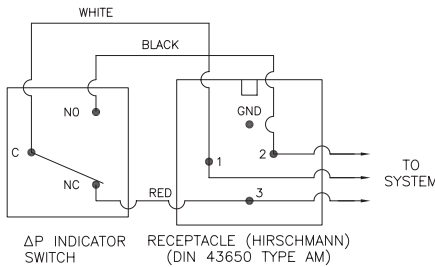
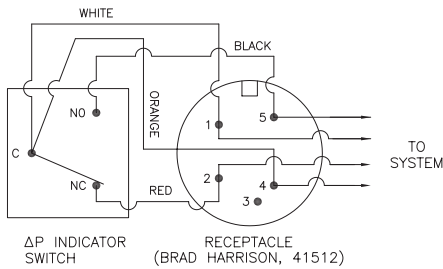

Note: The female plug (connector) is to be furnished by customer.

Dimensions:  
millimeters/(inches)

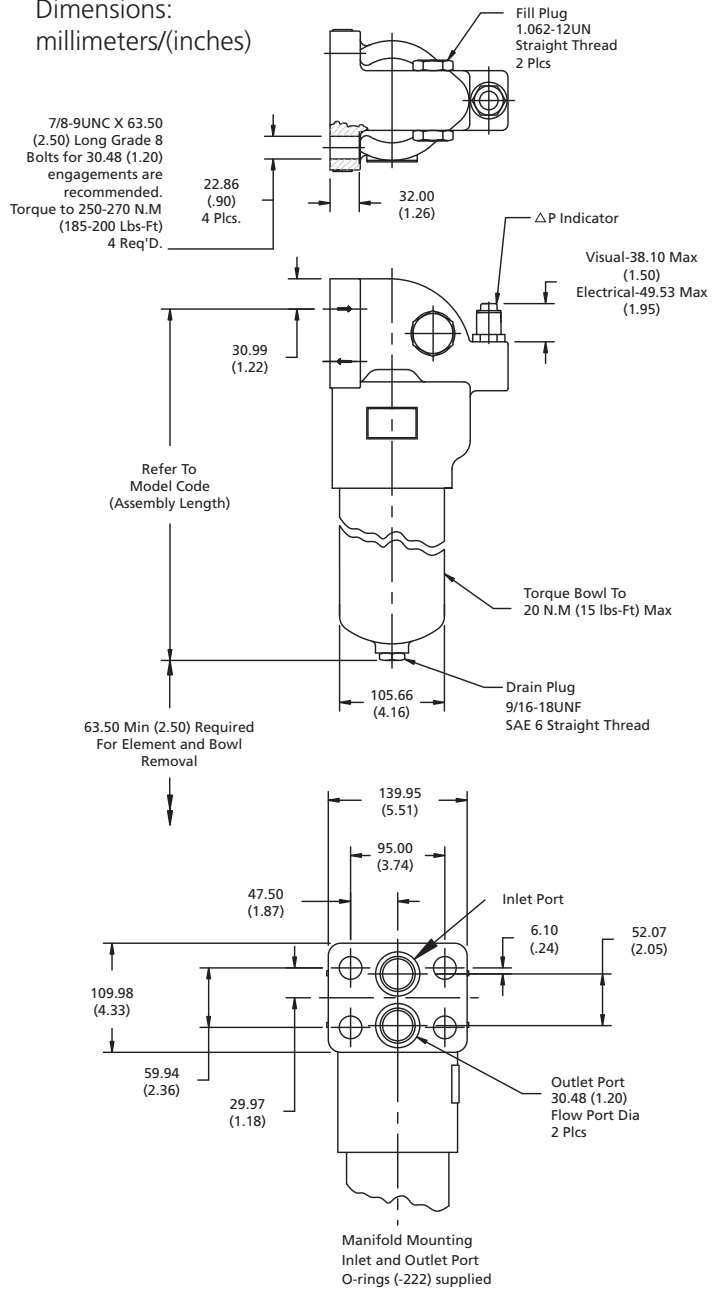

**Differential Indicators:** Indicators are designed to actuate at approximately 80% of bypass valve cracking pressure. It is recommended that an indicator with a bypass setting of 100 psid is used with a non-bypass housing.

**Surge Control:** This optional feature is used to dampen pressure surges or spikes to avoid premature actuation of the indicator. Surge control delays the indicator response.

**Thermal Lockout:** The Thermal Lockout prevents premature signaling of a bypass condition created by viscous fluid during cold start-ups. Normal indicator actuation capability is resumed once the operating temperature of the fluid reaches approximately 80 Deg. F.

## FEATURES

Filter assembly W621 is manufactured to meet the HF3 automotive standard. Working pressure up to 6000 psi combined with a choice of 3 bowl lengths offer a wide range of flows and dirt holding capabilities. This T-type head design offers an option to the W620 L-type port option. Our standard bowl drain plug helps relieve system pressure during filter change outs. Western Filter's proprietary BetaPore™ 5 layer media is offered in a variety of Pak designs. Five different media grades are offered down to 4.0µ(c). WF elements core collapse options range from 150 to 3000 PSI. The differential pressure indicator line is designed to work with the wide assortment of bypass valves. Thermal lockout and surge control are two key features incorporated in many of the valves.

Western Filter elements are compatible with petroleum oils, water glycol, oil/water, HWCF and synthetic fluids.

### Technical Data:

Maximum Working Pressure	6000 psi (414 bar)
Fatigue Pressure Rating	4000 psi max (276 bar)
Typical Burst Pressure	15000 psi max (1034 bar)
Temperature Range	Operating
Buna N	-45°F to + 225°F (-43°C to + 107°C)
Viton	-20°F to + 250°F (-29°C to + 121°C)
Head Material	Cast Iron
Bowl Material	Steel
Weight (without elements)	
Assembly length 1	34 lbs. (15,5 kg.)
Assembly length 2	38 lbs. (17,3 kg.)
Assembly length 4	42 lbs. (19,1 kg.)

## W621

120 gpm (379 l/min)

Conforms to HF3 specifications

Replacement element available in C-Pak™ or H-Pak™ media

Accepts coreless elements with removable coretube

Wide range of indicator options

Three bowl length options for design flexibility

Available with reverse flow bypass option for hydrostatic applications



## ACCESSORIES

Seal Kit -Buna N	P-236860-01
Seal Kit -E.P.R.	P-236860-02
Seal Kit -Viton	P-236860-03
Core Tube Assembly-Code Length-1	PW621R1BN
Core Tube Assembly-Code Length-2	PW621R2BN
Core Tube Assembly-Code Length-4	PW621R4BN

### Housing and Filter Element

Flow versus Pressure Drop

150 SUS (32 cSt.) oil with specific gravity  $\leq 0.9$

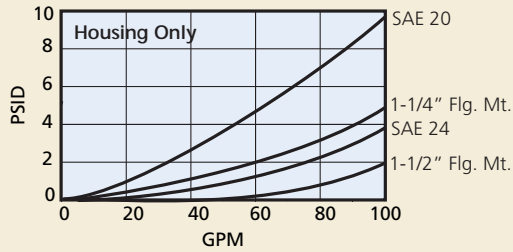

**Viscosity Correction Formula**

$$\Delta P \text{ Element} = \text{psid from catalog} \times \frac{\text{New Viscosity (SUS)}}{150} \times \frac{\text{New Specific Gravity}}{0.90}$$

$$\Delta P \text{ Housing} = \text{psid from catalog} \times \frac{\text{New Specific Gravity}}{0.90}$$

$$\Delta P \text{ Assembly} = \Delta P \text{ Element} + \Delta P \text{ Housing}$$

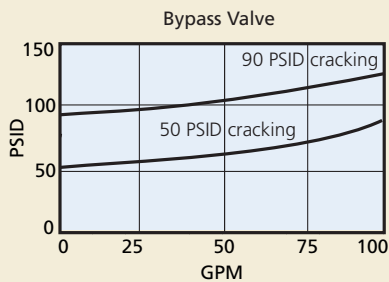
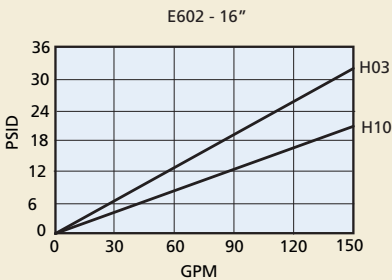
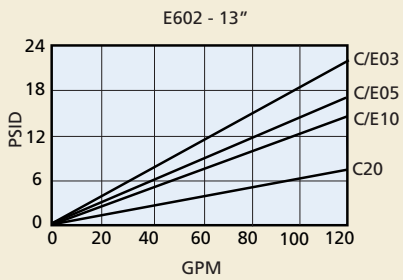
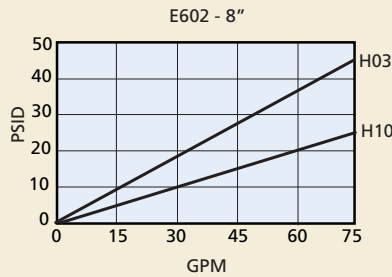
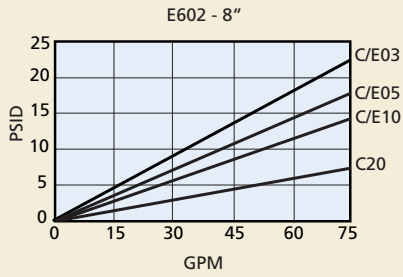
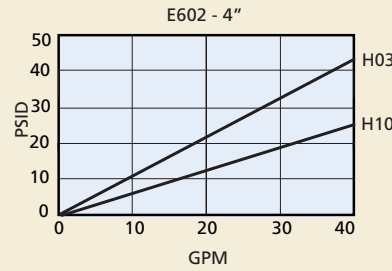
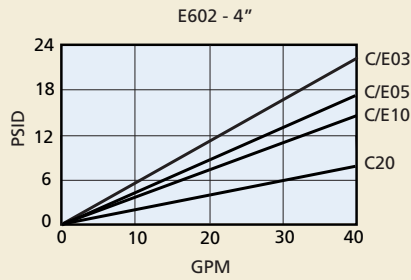

LOW PRESSURE  
SPIN-ON FILTERS

MEDIUM PRESSURE  
SPIN-ON FILTERS

IN-TANK FILTERS

LOW PRESSURE FILTERS

MEDIUM PRESSURE FILTERS

HIGH PRESSURE FILTERS

Filter Assembly	<b>W621</b> TABLE 1	<b>1</b> TABLE 2	<b>C</b> TABLE 3	<b>4</b> TABLE 4	<b>D B</b> TABLE 5	<b>B</b> TABLE 6	<b>2</b> TABLE 7	<b>C</b> TABLE 8	<b>10</b> TABLE 9
Service Element	<b>E602</b> TABLE 1	<b>1</b> TABLE 2	<b>B</b> TABLE 6	<b>2</b> TABLE 7	<b>C</b> TABLE 8	<b>10</b> TABLE 9			

 Order model code **W6211Q4MNB4C10** for same day shipment.

**Table 1**

Filter Assembly / Service Element	
CODE	DESCRIPTION
W621	Assembly
E602	Element

**Table 2**

Element Collapse Options	
CODE	DESCRIPTION
1	150 psid for housing w/bypass valve
4	3000 psi for housing w/o bypass valve (H-Pak™ only)

**Note:** E-Pak™ elements rated at 100 psid collapse. If used in non-bypass housing, a differential pressure indicator (70 psid max.) should be used.

**Table 3**

Port Size Options	
CODE	PORT SIZE
C	1-5/8" - 12 UN (SAE 20)
D	1-7/8" - 12 UN (SAE 24)
E	1-1/2" 4 Bolt Flange Code 61
G	1-1/4" 4 Bolt Flange Code 61
Q	1-1/4" 4 Bolt Flange Code 62
R	1-1/2" SAE 4 Bolt Flange Code 62

**Table 4**

Bypass Setting Options	
CODE	BYPASS SETTING
1	Non-bypass
4	50 psid
6	90 psid
8	Non-bypass w/reverse flow valve
9	50 psid w/reverse flow valve

**Note:** Use option 1 only with 3000 psid collapse filter element.

**Table 5 (Primary)**

Indicator Style and Setting	
CODE	ΔP INDICATOR STYLE & SETTING
A	Visual indicator 70 psid w/TL and surge
B	Electrical/visual 70 psid w/TL and surge
D	Electrical/visual 35 psid
E	Electrical/visual 100 psid
G	Electrical/visual 35 psid w/TL
I	Visual indicator 70 psid
J	ΔP indicator plug
L	Visual indicator 35 psid
M	Visual indicator 35 psid w/ TL and surge
N	Electrical/visual 35 psid w/12" 3-wire flying lead
O	Visual indicator 100 psid
P	Visual indicator 100 psid w/ TL and surge
R	Electrical switch 35 psid
S	Electrical/visual 100 psid w/12" 3-wire flying lead
T	Electrical switch 100 psid
U	Electrical switch 70 psid
V	Electrical/visual 70 psid w/TL
W	Electrical/visual 100 psid w/TL
Y	Electrical/visual 35 psid w/TL and surge
Z	Electrical/visual 100 psid w/TL and surge

TL (thermal lockout)

**Table 5 (Secondary)**

Receptacle Options	
CODE	ELECTRICAL STYLE
B	Brad Harrison (5-pin)
H	Hirschmann (4-pin)
N	None, for visual ΔP

**Table 6**

Seal Options	
CODE	MATERIAL
B	Buna N
E	E.P.R.
V	Viton

**Table 7**

Assembly & Element Length	
CODE (LGTH)	ELEMENT LENGTH
1 (8.04")	4.0"
2 (11.67")*	8.0"*
4 (16.39")	13.0"

\*HF3

**Table 8**

Element Code	
CODE	DESCRIPTION
C	(Glass) 01, 03, 05, 10, 20
E	(Coreless) 01, 03, 05, 10
H	(Glass) 03, 10
W	(Water Removal) 10

**Table 9**

Media Rating	
CODE	TARGET FLUID CLEANLINESS LEVEL
01	Flushing only
03	16/14/12 or better
05	18/16/14 or better
10	20/18/15 or better
20	22/19/16 or better

*Note: Information concerning fluid cleanliness codes is on page 6, the Media Grade Selection Guide.*

**Metric Porting Available**

Change W621 to G621

Porting code C becomes G1-1/4" ISO 228 BSP

Porting code D becomes G1-1/2" ISO 228 BSP

Porting code E becomes 1-1/2" SAE 4 bolt flange with M12 mounting threads

Porting code G becomes 1-1/4" SAE 4 bolt flange with M10 mounting threads

Porting code Q becomes 1-1/4" SAE 4 bolt flange with M14 mounting threads

Porting code R becomes 1-1/2" SAE 4 bolt flange with M16 mounting threads

Indicator Switch Schematic Wiring Diagram

Aluminum Electrical Housings

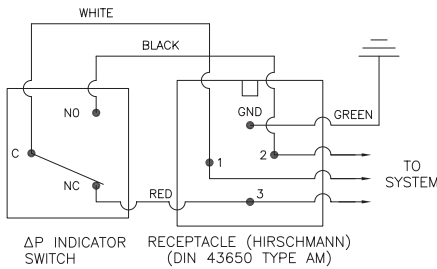
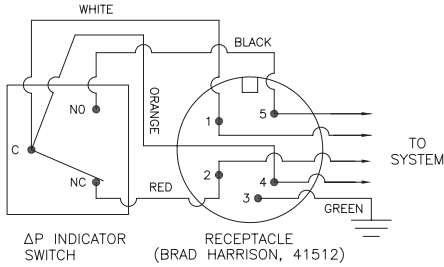

Note: The female plug (connector) is to be furnished by customer.

Plastic Electrical Housings

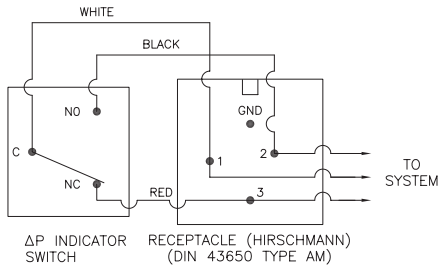
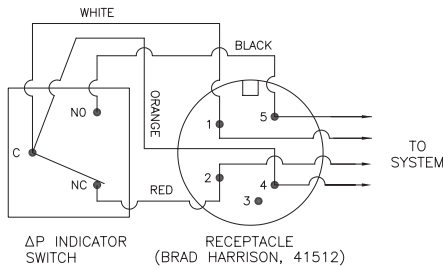

Note: The female plug (connector) is to be furnished by customer.

Dimensions:  
millimeters/(inches)

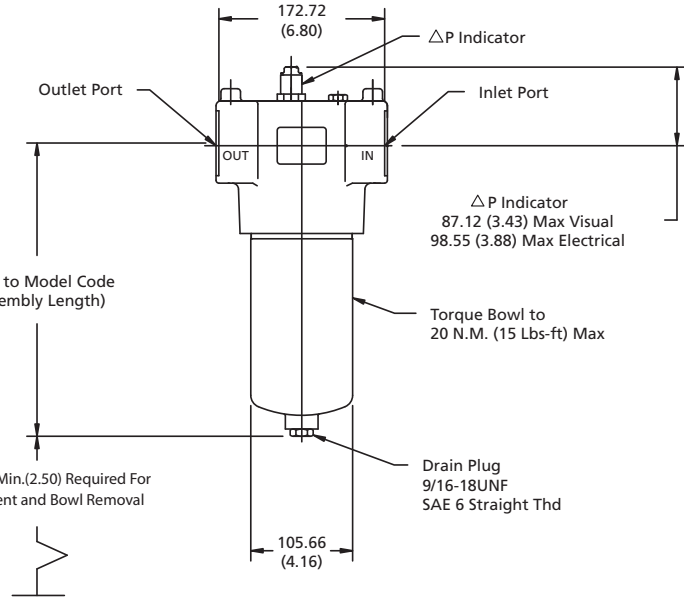
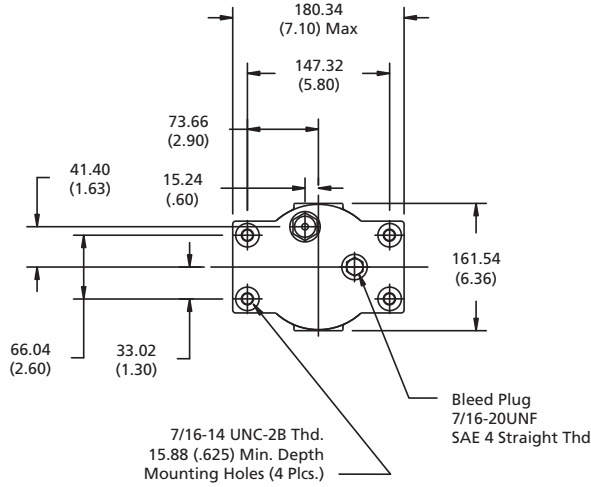

**Differential Indicators:** Indicators are designed to actuate at approximately 80% of bypass valve cracking pressure. It is recommended that an indicator with a bypass setting of 100 psid is used with a non-bypass housing.

**Surge Control:** This optional feature is used to dampen pressure surges or spikes to avoid premature actuation of the indicator. Surge control delays the indicator response.

**Thermal Lockout:** The Thermal Lockout prevents premature signaling of a bypass condition created by viscous fluid during cold start-ups. Normal indicator actuation capability is resumed once the operating temperature of the fluid reaches approximately 80 Deg. F.