

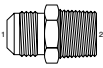

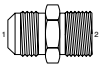

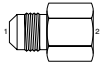

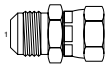

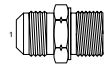
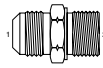
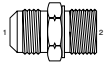
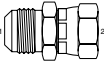
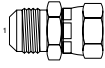
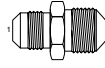
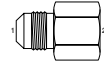
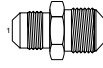
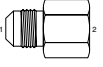
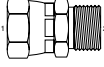
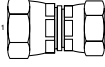
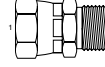
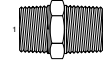
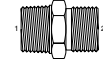

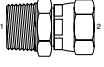
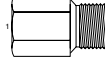
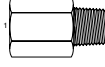
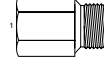
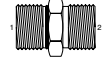
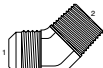
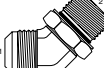
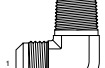
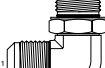
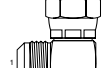
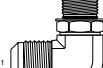



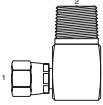
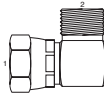





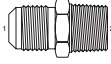
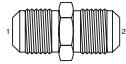
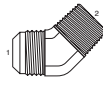
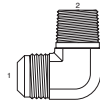



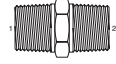

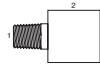

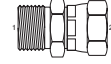

International Fittings

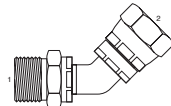
International Fittings

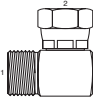
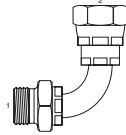
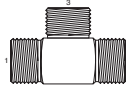
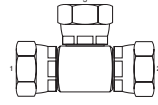
Brennan Industries, Inc.'s steel and stainless steel international fittings are designed for the hydraulic systems using threads that are the standard throughout the world. These include British (BSPP, BSPT), Japanese (JIS, Komatsu) and German (DIN) threads. Brennan currently offers these fittings in a wide range of sizes and configurations.

 7000 MJ-MBSPT	 7002 MJ-MBSPP	 7003 MJ-FBSPP	 7004 MJ-FBSPPS	 7005 MJ-MM Port Metric	 7005-L MJ-MM Light Metric (Dual Purpose)
 7005-S MJ-MM Heavy Metric (Dual Purpose)	 7007-L MJ-FMS Light Metric	 7007-S MJ-FMS Heavy Metric	 7008 MJ-MJIS Union	 7008-F MJ-FJIS	 7009 Komatsu MJ-MK Union
 7009-F Komatsu MJ-FK	 7022 FJS-MBSPP	 7023 FJS-FBSPP	 7025 FJS-MM Metric	 7030 MP-MBSPT Nipple	 7032 MP-MBSPP Nipple
 7033 MP-FBSPP	 7034 MP-FBSPPS	 7042 FP-MBSPP	 7040 FNPT/MBSPT	 7045 FP-MM Metric	 7062 MORB-MBSPP
 7100 MJ-MBSPT 45° Elbow	 7102-NWO MJ-MBSPPADJ 45° Elbow	 7200 MJ-MBSPT 90° Elbow	 7202-NWO MJ-MBSPPADJ 90° Elbow	 7204-NWO MJ-FBSPPS 90° Elbow	 7205-NWO MJ-MMADJ 90° Elbow

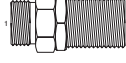
International Fittings

 <p>7220 FJS-MBSPT 90° Elbow</p>	 <p>7222 FJS-MBSPP 90° Elbow</p>	 <p>7588-P MJIS Plug</p>	 <p>7599-P Komatsu MK Plug</p>	 <p>7688-C FJIS Cap</p>	 <p>7699-C Komatsu FK Cap</p>
 <p>8055 Metric MM-MM Nipple</p>	 <p>8080 MJIS-MBSPT</p>	 <p>8088 MJIS-MJIS Union</p>	 <p>8180 MJIS-MBSPT 45° Elbow</p>	 <p>8280 MJIS-MBSPT 90° Elbow</p>	 <p>8555-H Metric MM Hollow Hex Plug</p>
 <p>8555-P Metric MM Plug 1.5 Pitch</p>	 <p>8800 Metric Bonded Seal</p>	 <p>9000 MBSPT-MBSPT Nipple</p>	 <p>9001 MBSPT-FBSPT Bushing</p>	 <p>9002 MBSPT-FBSPT 90° Elbow</p>	 <p>9020 MBSPP-MBSPT Straight</p>
 <p>9022 MBSPP-MBSPP Nipple</p>	 <p>9023 MBSPP-FBSPP</p>	 <p>9024 MBSPP-FBSPPS</p>	 <p>9025 Metric MBSPP-MM Nipple</p>	 <p>9033 FBSPP-FBSPP Coupling</p>	 <p>9124 MBSPP-FBSPPS Swept 45°</p>
 <p>9222 MBSPP-MBSPP 90°</p>	 <p>9224 MBSPP-FBSPPS 90°</p>	 <p>9224-L MBSPP-FBSPPS 90° Long</p>	 <p>9322 MBSPP-MBSPP-MBSPP Tee</p>	 <p>9344 FBSPP-FBSPP-FBSPP Tee</p>	 <p>9500-P MBSPT Plug</p>
 <p>9522-H MBSPP Hollow Hex Plug</p>	 <p>9522-P MBSPP Hollow Hex Plug</p>	 <p>9644-C FBSPP Cap</p>	 <p>9722-LN MBSPP-MBSPP Bulkhead</p>	 <p>9900 British Bonded Seal</p>	 <p>9925 BSPP Locknut</p>

MJ-MBSPT 7000 Series

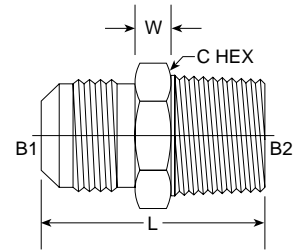

PART NO. SIZE	TUBE O.D.	B1 JIC	B2 BSPT	L LGTH M.M.	W WIDTH M.M.	C HEX M.M.	Standard Material From Stock			
							S	FG	SS	B
7000-04-02	1/4	7/16-20	1/8-28	30.48	5.58	12.70	•			
7000-04-04	1/4	7/16-20	1/4-19	38.23	7.64	14.28	•			
7000-04-06	1/4	7/16-20	3/8-19	38.83	7.64	17.46	•			
7000-05-04	5/16	1/2-20	1/4-19	37.83	7.60	14.28	•			
7000-06-04	3/8	9/16-18	1/4-19	38.10	7.64	15.88	•			
7000-06-06	3/8	9/16-18	3/8-19	39.89	7.64	17.46	•			
7000-06-08	3/8	9/16-18	1/2-14	44.07	7.64	22.22	•			
7000-08-06	1/2	3/4-16	3/8-19	41.41	8.28	20.63	•			
7000-08-08	1/2	3/4-16	1/2-14	47.88	7.64	22.22	•			
7000-10-08	5/8	7/8-14	1/2-14	50.05	8.65	25.40	•			
7000-10-12	5/8	7/8-14	3/4-14	51.83	10.17	28.16	•			
NEW 7000-12-08							•			
7000-12-12	3/4	1 1/16-12	3/4-14	53.95	10.17	28.59	•			
7000-12-16	3/4	1 1/16-12	1-11	60.65	10.17	34.93	•			
7000-16-12	1	1 5/16-12	3/4-14	55.17	10.17	35.01	•			
7000-16-16	1	1 5/16-12	1-11	61.21	10.17	34.93	•			
7000-20-20	1 1/4	1 5/8-12	1 1/4-11	65.02	12.70	47.64	•			
7000-24-24	1 1/2	1 7/8-12	1 1/2-11	70.09	12.70	52.38	•			

International Fittings

MJ-MBSPP 7002 Series

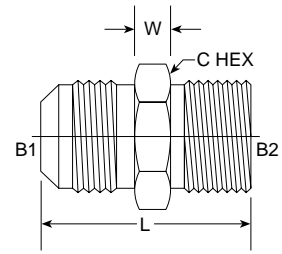

PART NO. SIZE	TUBE O.D.	B1 JIC	B2 BSPP	L M.M.	W WIDTH M.M.	C HEX M.M.	Standard Material From Stock			
							S	FG	SS	B
7002-04-02	1/4	7/16-20	1/8-28	39.00	8.00	16.00	•			
7002-04-04	1/4	7/16-20	1/4-19	32.00	5.00	19.00	•			
7002-04-06	1/4	7/16-20	3/8-19	33.00	5.00	22.00	•			
7002-04-08	1/4	7/16-20	1/2-14	39.00	5.00	30.00	•			
7002-05-02	5/16	1/2-20	1/8-28	32.00	7.00	15.21	•			
7002-05-04	5/16	1/2-20	1/4-19	31.00	6.00	18.00	•			
7002-05-06	5/16	1/2-20	3/8-19	34.00	6.00	23.33	•			
7002-05-12	5/16	1/2-20	3/4-14	41.00	8.00	33.00	•			
7002-06-02	3/8	9/16-18	1/8-28	33.00	7.00	16.00	•			
7002-06-04	3/8	9/16-18	1/4-19	33.00	7.00	18.00	•			
7002-06-06	3/8	9/16-18	3/8-19	33.00	7.00	22.00	•			
7002-06-08	3/8	9/16-18	1/2-14	37.00	8.00	26.00	•			
7002-06-10	3/8	9/16-18	5/8-14	40.00	8.00	28.00	•			
7002-06-12	3/8	9/16-18	3/4-14	41.00	9.00	33.00	•			
7002-08-04	1/2	3/4-16	1/4-19	36.00	8.00	21.00	•			
7002-08-06	1/2	3/4-16	3/8-19	36.00	8.00	22.00	•			
7002-08-08	1/2	3/4-16	1/2-14	40.00	8.00	26.00	•			
7002-08-10	1/2	3/4-16	5/8-14	43.00	8.00	28.00	•			
7002-08-12	1/2	3/4-16	3/4-14	44.00	8.00	33.00	•			
7002-08-16	1/2	3/4-16	1-11	46.30	8.50	43.00	•			
7002-10-04	5/8	7/8-14	1/4-19	39.40	8.50	26.00	•			
7002-10-06	5/8	7/8-14	3/8-19	40.00	8.00	26.00	•			
7002-10-08	5/8	7/8-14	1/2-14	40.00	8.00	26.00	•			
7002-10-10	5/8	7/8-14	5/8-14	45.00	8.00	28.00	•			
7002-10-12	5/8	7/8-14	3/4-14	46.50	8.50	33.00	•			
7002-10-16	5/8	7/8-14	1-11	48.50	8.50	43.00	•			
7002-12-06	3/4	1 1/16-12	3/8-19	45.30	10.00	29.00	•			
7002-12-08	3/4	1 1/16-12	1/2-14	47.10	10.00	29.00	•			
7002-12-10	3/4	1 1/16-12	5/8-14	49.41	9.50	28.60	•			
7002-12-12	3/4	1 1/16-12	3/4-14	50.80	9.50	33.00	•			
7002-12-16	3/4	1 1/16-12	1-11	52.60	10.50	43.00	•			
7002-12-20	3/4	1 1/16-12	1 1/4-11	52.80	10.50	53.00	•			
7002-14-12	5/8	1 3/16-12	3/4-14	51.30	9.50	33.00	•			
7002-16-08	1	1 5/16-12	1/2-14	48.93	10.50	35.00	•			
7002-16-12	1	1 5/16-12	3/4-14	53.50	10.50	35.00	•			
7002-16-16	1	1 5/16-12	1-11	54.40	11.50	43.00	•			
7002-16-20	1	1 5/16-12	1 1/4-11	53.30	10.50	52.00	•			
7002-16-24	1	1 5/16-12	1 1/2-11	58.50	13.50	56.00	•			
7002-20-12	1 1/4	1 5/8-12	3/4-14	53.90	10.50	47.00	•			
7002-20-16	1-1/4	1 5/8-12	1-11	56.20	11.40	47.00	•			
7002-20-20	1 1/4	1 5/8-12	1 1/4-11	57.30	12.50	52.00	•			
7002-20-24	1 1/4	1 5/8-12	1 1/2-11	58.20	12.50	57.00	•			
7002-24-16	1 1/2	1 7/8-12	1-11	61.80	13.50	52.00	•			
7002-24-20	1 1/2	1 7/8-12	1 1/4-11	62.14	14.18	52.00	•			
7002-24-24	1 1/2	1 7/8-12	1 1/2-11	61.90	12.50	57.00	•			
7002-24-32	1 1/2	1 7/8-12	2-11	67.20	14.50	70.00	•			
7002-32-32	2	2 1/2-12	2-11	76.80	17.50	70.00	•			

MJ-FBSPP 7003 Series

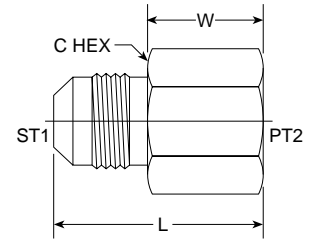

PART NO. SIZE	TUBE O.D.	ST1 JIC	PT2 BSPP	L LGTH M.M.	W WIDTH M.M.	C1 HEX M.M.	Standard Material From Stock			
							S	FG	SS	B
NEW 7003-04-02										
NEW 7003-04-04										
NEW 7003-04-06										
NEW 7003-06-04										
NEW 7003-06-06										
NEW 7003-06-08										
NEW 7003-08-06										
NEW 7003-08-08										
NEW 7003-08-10										
NEW 7003-08-12										
NEW 7003-10-08										
NEW 7003-10-10										
NEW 7003-10-12										
NEW 7003-12-12										
NEW 7003-12-16										
NEW 7003-16-16										
NEW 7003-20-20										
NEW 7003-24-24										
NEW 7003-32-32										

MJ-FBSPPS 7004 Series

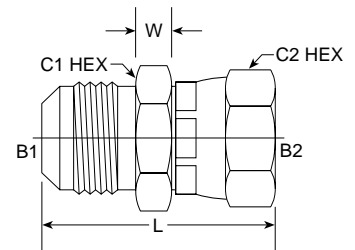

PART NO. SIZE	TUBE O.D.	B1 JIC	B2 BSPP	L LGTH M.M.	W WIDTH M.M.	C1 HEX M.M.	C2 HEX M.M.	Standard Material From Stock			
								S	FG	SS	B
7004-04-02	1/4	7/16-20	1/4-19	36.16	6.90	14.28	15.00	•			
7004-04-04	1/4	7/16-20	1/4-19	36.50	8.50	18	18	•			
7004-04-06	1/4	7/16-20	1/4-19	43.50	8.50	24	22	•			
7004-06-04	3/8	9/16-18	1/4-19	36.00	6.00	18	18	•			
7004-06-06	3/8	9/16-18	3/8-19	40.50	6.50	21	22	•			
7004-06-08	3/8	9/16-18	3/8-19	43.10	7.00	26	26	•			
7004-08-06	1/2	3/4-16	3/8-19	44.70	7.50	21	22	•			
7004-08-08	1/2	3/4-16	1/2-14	49.00	9.50	26	26	•			
7004-08-10	1/2	3/4-16	5/8-14	48.20	8.00	26	28	•			
7004-08-12	1/2	3/4-16	3/4-14	50.50	10.00	29	33	•			
7004-10-08	5/8	7/8-14	1/2-14	51.60	10.00	26	26	•			
7004-10-10	5/8	7/8-14	5/8-14	53.20	9.50	28	28	•			
NEW 7004-12-12								•			
7004-12-16	3/4	1 1/16-12	1-11	58.80	11.00	38	38	•			
7004-16-12	1	1 5/16-12	3/4-14	58.01	11.10	34.90	33.00	•			
NEW 7004-16-16								•			
7004-20-20	1 1/4	1 7/8-12	1 1/4-11	64.60	13.50	48	48	•			
NEW 7004-32-32								•			

International Fittings

MJ-MM Port Metric 7005 Series

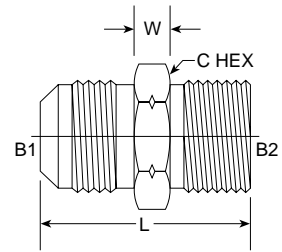

PART NO. SIZE	TUBE O.D.	B1 JIC	B2 MM	L LGTH M.M.	W WIDTH M.M.	C HEX M.M.	Standard Material From Stock			
							S	FG	SS	B
7005-04-10	1/4	7/16-20	10 x 1.0	30.30	4.00	14	•			
7005-04-12	1/4	7/16-20	12 x 1.5	32.520	6.10	15.25	•			
NEW 7005-04-14							•			
NEW 7005-05-12							•			
7005-06-12	3/8	9/16-18	12 x 1.5	32.60	6.00	15	•			
7005-06-14	3/8	9/16-18	14 x 1.5	32.80	6.50	18	•			
7005-06-16	3/8	9/16-18	16 x 1.5	34.10	6.50	22	•			
7005-06-18	3/8	9/16-18	18 x 1.5	34.20	6.50	22	•			
7005-08-12	1/2	3/4-16	12 x 1.5	36.92	8.05	20.80	•			
7005-08-14	1/2	3/4-16	14 x 1.5	37.30	8.40	21	•			
7005-08-16	1/2	3/4-16	16 x 1.5	38.00	8.00	22	•			
7005-08-18	1/2	3/4-16	18 x 1.5	37.80	8.00	22	•			
7005-08-20	1/2	3/4-16	20 x 1.5	37.85	8.10	25.65	•			
7005-08-22	1/2	3/4-16	22 x 1.5	37.40	7.00	27	•			
NEW 7005-10-18							•			
7005-10-20	5/8	7/8-14	20 x 1.5	40.00	8.00	26	•			
7005-10-22	5/8	7/8-14	22 x 1.5	40.30	7.50	27	•			
7005-12-22	3/4	1 1/16-16	22 x 1.5	45.80	10.00	27	•			
7005-12-27	3/4	1 1/16-12	27 x 2	52.45	9.00	31.91	•			
7005-16-33	1	1 5/16-12	33 x 1.5	54.54	9.55	40.90	•			
NEW 7005-24-48							•			

MJ-MM Light Metric (Dual Purpose) 7005-L Series

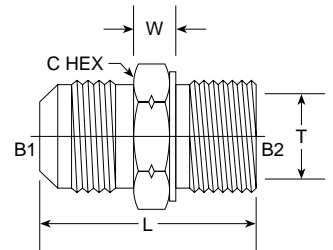

PART NO. SIZE	TUBE O.D.	B1 JIC	B2 MM	L LGTH M.M.	T WIDTH M.M.	W WIDTH M.M.	C HEX M.M.	Standard Material From Stock			
								S	FG	SS	B
7005-04-L06-12	1/4	7/16-20	12 x 1.5	31.50	6	7.50	16.00	•			
7005-04-L08-14	1/4	7/16-20	14 x 1.5	32.83	8	6.40	18.00	•			
7005-06-L08-14	3/8	9/16-18	14 x 1.5	32.10	8	7.75	18.98	•			
7005-06-L10-16	3/8	9/16-18	16 x 1.5	33.73	10	9.52	22.22	•			
7005-06-L12-18	3/8	9/16-18	18 x 1.5	36.40	12	8.80	23.00	•			
7005-08-L10-16	1/2	3/4-16	16 x 1.5	38.38	10	8.00	22.00	•			
7005-08-L12-18	1/2	3/4-16	18 x 1.5	38.30	12	10.00	23.00	•			
7005-12-L18-24	3/4	1 1/16-12	24 x 1.5	51.95	18	12.12	31.75	•			
7005-10-L15-22	5/8	7/8-14	22 x 1.5	43.00	15	10.00	27.00	•			
7005-12-L18-26	3/4	1 1/16-12	26 x 1.5	51.00	18	12.50	31.70	•			
7005-12-L22-30	3/4	1 1/16-12	30 x 2.0	52.60	22	12.50	38.20	•			
7005-16-L28-36	1	1 5/16-12	36 x 2.0	53.70	28	14.00	41.20	•			
NEW 7005-20-L35-45								•			

MJ-MM Heavy Metric (Dual Purpose) 7005-S Series

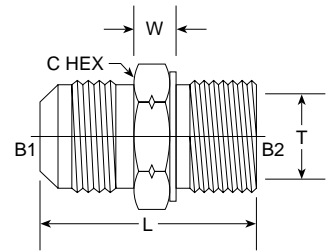

PART NO. SIZE	TUBE O.D.	B1 JIC	B2 MM	L LGTH M.M.	T WIDTH M.M.	W WIDTH M.M.	C1 HEX M.M.	Standard Material From Stock			
								S	FG	SS	B
7005-04-S06-14	1/4	7/16-20	14 x 1.5	33.40	6	8.00	19	•			
7005-04-S08-16	1/4	7/16-20	16 x 1.5	34.50	8	8.50	23	•			
7005-06-S10-18	3/8	9/16-18	18 x 1.5	37.40	10	8.50	23	•			
7005-06-S12-20	3/8	9/16-18	20 x 1.5	36.90	12	10.50	27	•			
7005-08-S10-18	1/2	3/4-16	18 x 1.5	37.50	10	9.00	24	•			
7005-08-S12-20	1/2	3/4-16	20 x 1.5	41.50	12	10.00	26	•			
7005-08-S14-22	1/2	3/4-16	22 x 1.5	41.70	14	11.50	27	•			
7005-10-S12-20	5/8	7/8-14	20 x 1.5	42.60	12	10.00	29	•			
7005-10-S16-24	5/8	7/8-14	24 x 1.5	44.80	16	10.00	29	•			
NEW 7005-12-S16-24								•			
7005-12-S20-30	3/4	1 1/16-12	30 x 1.5	53.51	20	14.00	38.10	•			
7005-12-S25-36	3/4	1 1/16-12	36 x 2.0	53.00	25	13.50	45	•			
7005-16-S30-42	1	1 5/16-12	42 x 2.0	42.30	30	13.50	48	•			
7005-24-S38-52	1 1/2	1 7/8-12	52 x 2.0	66.20	38	16.50	57	•			

MJ-FMS Light Metric 7007-L Series

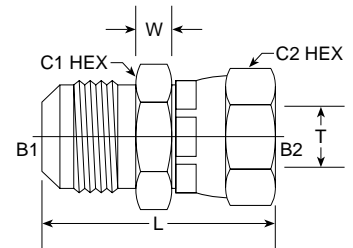

PART NO. SIZE	TUBE O.D.	B1 JIC	B2 MS	L LGTH M.M.	T WIDTH M.M.	W WIDTH M.M.	C1 HEX M.M.	C2 HEX M.M.	Standard Material From Stock			
									S	FG	SS	B
7007-05-L06-12	5/16	1/2-20	12 x 1.5	38.00	6	6.50	15	18	•			
7007-06-L08-14	3/8	9/16-18	14 x 1.5	39.00	8	6.50	16	18	•			
7007-06-L10-16	3/8	9/16-18	16 x 1.5	40.60	10	8.15	18	20.80	•			
7007-06-L12-18	3/8	9/16-18	18 x 1.5	41.00	12	7.00	18	24	•			
7007-06-L15-22	3/8	9/16-18	22 x 1.5	42.00	15	8.15	20.80	26.95	•			
7007-08-L10-16	1/2	3/4-16	16 x 1.5	43.80	16	8.05	20.60	20.80	•			
7007-08-L12-18	1/2	3/4-16	18 x 1.5	44.30	12	8.00	21	26	•			
7007-08-L15-22	1/2	3/4-16	22 x 1.5	44.50	15	7.50	21	27	•			
7007-10-L15-22	5/8	7/8-14	22 x 1.5	47.60	15	8.00	26	27	•			

International Fittings

MJ-FMS Heavy Metric 7007-S Series

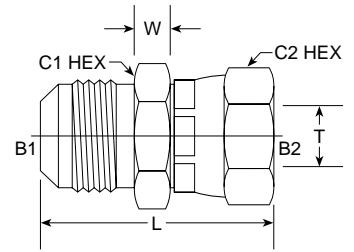

PART NO. SIZE	TUBE O.D.	B1 JIC	B2 MS	L LGTH M.M.	T WIDTH M.M.	W WIDTH M.M.	C1 HEX M.M.	C2 HEX M.M.	Standard Material From Stock			
									S	FG	SS	B
7007-06-S12-20	3/8	9/16-18	20 x 1.5	44.30	12	7.50	18	26	•			
7007-08-S12-20	1/2	3/4-16	20 x 1.5	44.30	12	8.00	21	26	•			
NEW 7007-10-S12-20									•			
NEW 7007-20-S30-42									•			

MJ-MJIS Union 7008 Series

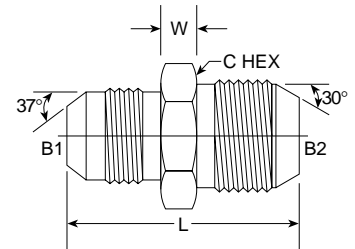

PART NO. SIZE	TUBE O.D.	B1 JIC	B2 JIS	L LGTH M.M.	W WIDTH M.M.	C HEX M.M.	Standard Material From Stock			
							S	FG	SS	B
7008-04-02	1/4	7/16-20	1/8-28	33.70	7	16	•			
7008-04-04	3/4	7/16-20	1/4-19	37.30	7	19	•			
7008-06-06	3/8	3/8-18	3/8-19	38.20	7	23	•			
7008-08-08	1/2	3/4-16	1/2-14	48.20	11	26	•			

MJ-FJIS 7008-F Series

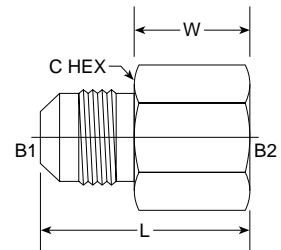

PART NO. SIZE	TUBE O.D.	B1 JIC	B2 JIS	L LGTH M.M.	W WIDTH M.M.	C HEX M.M.	Standard Material From Stock			
							S	FG	SS	B
7008-F-04-04	1/4	7/16-20	1/4-19	31.8	17.5	19	•			
7008-F-06-06	3/8	9/16-18	3/8-19	34.7	20.5	23	•			
7008-F-08-08	1/2	3/4-16	1/2-14	43.4	26.2	27	•			
7008-F-12-12	3/4	1 1/16-12	3/4-14	49.22	27.4	31.75	•			
NEW 7008-F-16-16	1	1 5/16-12	1-11				•			

Komatsu MJ-MK Union 7009 Series

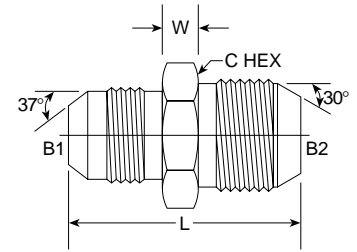

PART NO. SIZE	TUBE O.D.	B1 JIC	B2 MK	L LGTH M.M.	W WIDTH M.M.	C HEX M.M.	Standard Material From Stock			
							S	FG	SS	B
7009-04-14	1/4	7/16-20	14 x 1.5	36.20	6.50	19	•			
7009-06-18	3/8	9/16-18	18 x 1.5	41.20	7.00	23	•			
7009-08-22	1/2	3/4-16	22 x 1.5	47.80	10.00	24	•			
7009-10-24	5/8	7/8-14	24 x 1.5	51.30	10.00	27	•			
7009-12-30	3/4	1 1/16-12	30 x 1.5	60.80	11.50	35	•			
NEW 7009-16-33							•			

Komatsu MJ-FK Union 7009-F Series

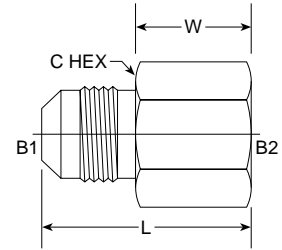

PART NO. SIZE	TUBE O.D.	B1 JIC	B2 FK	L LGTH M.M.	W WIDTH M.M.	C HEX M.M.	Standard Material From Stock			
							S	FG	SS	B
7009-F-04-14	1/4	7/16-20	14 x 1.5	36.92	23.20	19	•			
7009-F-06-18	3/8	9/16-18	18 x 1.5	36.80	22.50	24	•			
7009-F-08-22	1/2	3/4-16	22 x 1.5	42.50	25.50	27	•			
7009-F-10-24	5/8	7/8-14	24 x 1.5	41.80	22.50	32	•			
7009-F-12-30	3/4	1 1/16-12	30 x 1.5	52.50	27.50	39	•			

FJS-MBSPP 7022 Series

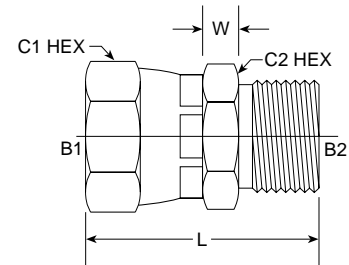

PART NO. SIZE	TUBE O.D.	B1 JIC	B2 BSPP	L LGTH M.M.	W WIDTH M.M.	C1 HEX M.M.	C2 HEX M.M.	Standard Material From Stock			
								S	FG	SS	B
7022-04-04	1/4	7/16-20	1/4-19	34.60	6.00	14.28	15	•			
7022-04-06	1/4	7/16-20	3/8-19	36.80	6.50	14.28	24	•			
NEW 7022-05-04								•			
7022-06-04	3/8	9/16-18	1/4-19	37.20	6.50	17.46	18	•			
7022-06-06	3/8	9/16-18	3/8-19	38.60	6.50	17.46	24	•			
7022-06-08	3/8	9/16-18	1/2-14	42.70	8.50	17.46	26	•			
7022-08-06	1/2	3/4-18	3/8-19	43.80	7.50	22.23	24	•			
7022-08-08	1/2	3/4-18	1/2-14	47.30	8.50	22.23	26	•			
7022-10-08	5/8	7/8-14	1/2-14	50.30	9.00	25.40	26	•			
7022-10-10	5/8	7/8-14	5/8-14	51.60	7.50	25.40	28	•			
7022-12-12	3/4	1 1/16-12	3/4-14	51.10	11.00	31.75	36	•			
7022-16-16	1	1 5/16-12	1-11	60.10	10.30	38.00	42.42	•			
7022-20-20	1 1/4	1 5/8-12	1 1/4-11	62.00	11.40	47.60	52.00	•			
7022-24-24	1 1/2	1 7/8-12	1 1/2-11	69.20	13.00	56.30	56.30	•			

International Fittings

FJS-FBSPP 7023 Series

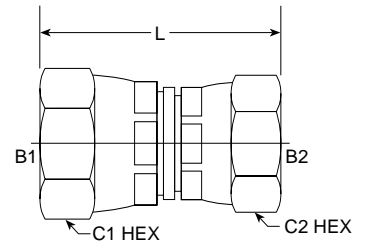

PART NO. SIZE	TUBE O.D.	B1 JIC	B2 BSPP	L LGTH M.M.	C1 HEX M.M.	C2 HEX M.M.	Standard Material From Stock			
							S	FG	SS	B
7023-04-04	1/4	7/16-20	1/4-19	36.00	14.28	18	•			
7023-06-06	3/8	9/16-18	3/8-19	41.30	17.46	21	•			
7023-06-08	3/8	9/16-18	1/2-14	44.80	17.46	26	•			
7023-08-06	1/2	3/4-16	3/8-19	46.20	22.23	22	•			
7023-08-08	1/2	3/4-16	1/2-14	47.80	22.23	26	•			

FJS-MM Metric 7025 Series

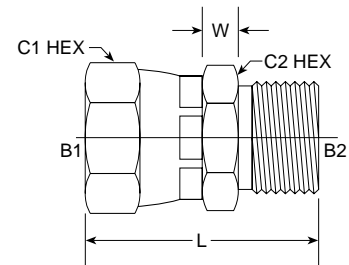

PART NO. SIZE	TUBE O.D.	B1 JIC	B2 MM	L LGTH M.M.	W WIDTH M.M.	C1 HEX M.M.	C2 HEX M.M.	Standard Material From Stock			
								S	FG	SS	B
7025-05-12	5/16	1/2-20	12 x 1.5	40.20	19.50	15.87	17	•			
7025-06-14	3/8	9/16-18	14 x 1.5	38.40	6.50	17.46	18	•			
7025-06-16	3/8	9/16-18	16 x 1.5	39.50	6.50	17.46	22	•			
7025-06-18	3/8	9/16-18	18 x 1.5	39.00	6.50	17.46	22	•			
7025-08-16	1/2	3/4-16	16 x 1.5	41.62	6.86	22.22	21.91	•			
NEW 7025-08-18								•			
7025-08-22	1/2	3/4-16	22 x 1.5	41.69	6.70	22.22	25.60	•			
7025-10-22	5/8	7/8-14	22 x 1.5	45.12	7.00	25.65	27.00	•			

MP-MBSPT Nipple 7030 Series

PART NO. SIZE	A1 NPTF	B2 BSPT	L LGTH M.M.	W WIDTH M.M.	C HEX M.M.	Standard Material From Stock			
						S	FG	SS	B
7030-04-04	1/4-18	1/4-19	38.30	7.50	14.20	•			
7030-04-06	1/4-18	3/8-19	39.00	7.90	17.45	•			
7030-06-04	3/8-18	1/4-19	38.40	7.50	17.40	•			
7030-06-06	3/8-18	3/8-19	40.10	8.50	17.40	•			
7030-08-08	1/2-14	1/2-14	49.90	8.50	22.20	•			
7030-12-12	3/4-14	3/4-14	51.70	10.00	27.70	•			
7030-16-16	1-11 1/2	1-11	66.20	13.00	34.80	•			
7030-20-20	1-1/4-11 1/2	1 1/4-11	65.80	12.50	47.60	•			
7030-24-24	1-1/2-11 1/2	1 1/2-11	69.80	14.00	57.15	•			
7030-32-32	2-11 1/2	2-11	70.60	14.00	69.80	•			

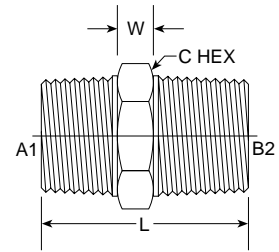

MP-MBSPP Nipple 7032 Series

PART NO. SIZE	A1 MP	B2 BSPP	L LGTH M.M.	W WIDTH M.M.	C HEX M.M.	Standard Material From Stock			
						S	FG	SS	B
7032-02-02	1/8-27	1/8-28	27.00	6.00	15.00	•			
7032-02-04	1/8-27	1/4-19	28.20	6.50	18.00	•			
7032-04-02	1/4-18	1/8-28	33.20	7.70	15.20	•			
7032-04-04	1/4-18	1/4-19	33.80	8.50	18.00	•			
7032-04-06	1/4-18	3/8-19	35.30	7.50	24.00	•			
7032-04-08	1/4-18	1/2-14	38.10	8.50	26.00	•			
7032-06-04	3/8-18	1/4-19	33.80	8.00	18.00	•			
7032-06-06	3/8-18	3/8-19	35.40	7.50	24.00	•			
7032-06-08	3/8-18	1/2-14	37.90	7.75	25.65	•			
NEW 7032-06-12						•			
7032-08-04	1/2-14	1/4-19	38.30	8.00	22.00	•			
7032-08-06	1/2-14	3/8-19	40.40	8.00	24.00	•			
7032-08-08	1/2-14	1/2-14	42.80	8.00	26.00	•			
7032-08-10	1/2-14	5/8-14	46.00	9.10	27.90	•			
7032-08-12	1/2-14	3/4-14	46.12	7.80	33.00	•			
7032-08-16	1/2-14	1-11	50.10	10.00	43.00	•			
7032-12-08	3/4-14	1/2-14	44.40	9.50	28.00	•			
7032-12-12	3/4-14	3/4-14	46.70	9.00	33.00	•			
7032-12-16	3/4-14	1-11	49.50	9.50	43.00	•			
NEW 7032-16-08						•			
7032-16-12	1-11 1/2	3/4-14	55.30	10.85	34.90	•			
NEW 7032-16-16						•			
NEW 7032-16-20						•			
7032-20-16	1 1/4-11 1/2	1-11	58.40	12.75	47.25	•			
7032-20-20	1 1/4-11 1/2	1-11	57.90	13.00	52.00	•			
NEW 7032-20-24						•			
NEW 7032-24-20						•			
7032-24-24	1 1/2-11 1/2	1 1/2-11	60.20	13.00	56.30	•			
NEW 7032-24-32						•			
7032-32-20	2-12	1 1/4-11	61.12	14.30	70.00	•			
7032-32-32	2-11 1/2	2-11	66.20	14.00	70.00	•			

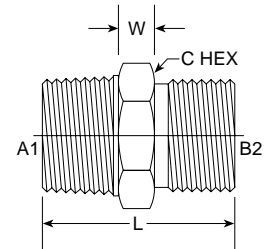

International Fittings

MP-FBSPP 7033 Series

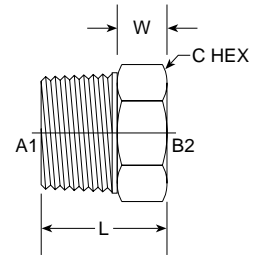

PART NO. SIZE	A1 MP	B2 BSPP	L LGTH M.M.	W WIDTH M.M.	C HEX M.M.	Standard Material From Stock			
						S	FG	SS	B
7033-04-04	1/4-18	1/4-19	38.20	23.70	18	•		•	
7033-08-06	1/2-14	3/8-19	25.30	6.50	22	•			
7033-08-08	1/2-14	1/2-14	47.68	28.00	26	•			
7033-12-12	3/4-14	3/4-14	52.05	32.70	33	•			
7033-16-16	1-11 1/2	1-11	61.50	37.00	43	•			
7033-20-20	1 1/4-11 1/2	1 1/4-11	58.47	33.20	50.75	•			
7033-24-24	1 1/2-11 1/2	1 1/2-11	56.60	32.00	57	•			
7033-32-32	2-11 1/2	2-11	71.30	44.60	70.10	•			

MP-FBSPPS 7034 Series

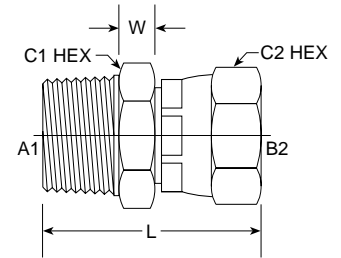

PART NO. SIZE	A1 MP	B2 BSPPS	L LGTH M.M.	W WIDTH M.M.	C1 HEX M.M.	C2 HEX M.M.	Standard Material From Stock			
							S	FG	SS	B
7034-02-02	1/8-27	18-28	32.40	7.00	15	15	•			
7034-02-04	1/8-27	1/4-19	33.00	7.00	16	18	•			
7034-04-04	1/4-18	1/4-19	38.00	7.00	15	18	•			
NEW 7034-04-06							•			
7034-06-04	3/8-18	1/4-19	39.00	8.80	18	18	•			
7034-06-06	3/8-18	3/8-19	43.60	8.50	18	22	•			
7034-06-08	3/8-18	1/2-14	45.20	8.50	24	26	•			
7034-08-06	1/2-14	3/8-19	48.40	10.00	22	21	•			
7034-08-08	1/2-14	1/2-14	51.20	9.50	22	26	•			
7034-12-08	3/4-14	1/2-14	52.72	10.50	28	26	•			
7034-12-12	3/4-14	3/4-14	52.40	9.50	28	33	•			
7034-16-16	1-11 1/2	1-11	63.34	11.00	38	38	•			

FNPT-MBSPT 7040 Series

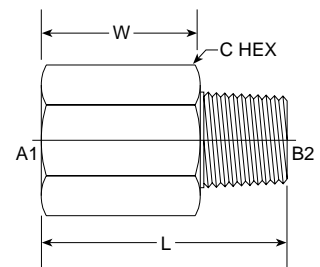

PART NO. SIZE	A1 MP	B2 BSPP	L LGTH M.M.	W WIDTH M.M.	C HEX M.M.	Standard Material From Stock			
						S	FG	SS	B
NEW 7040-02-02						•			
NEW 7040-04-04						•			
NEW 7040-06-06						•			
NEW 7040-08-08						•			
NEW 7040-12-12						•			

FP-MBSPP 7042 Series

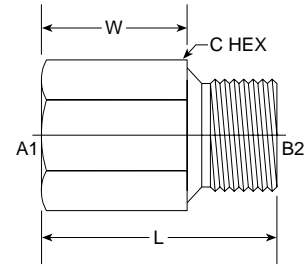

PART NO. SIZE	A1 FP	B2 BSPP	L LGTH M.M.	W WIDTH M.M.	C HEX M.M.	Standard Material From Stock			
						S	FG	SS	B
7042-02-02	1/8-27	1/8-28	27.37	16.13	15.20	•			
7042-02-04	1/8-27	1/4-19	30.80	19.30	19.00	•			
7042-02-06	1/2-27	3/8-19	34.40	20.20	24.00	•			
7042-04-02	1/4-18	1/8-28	30.90	22.10	19.05	•			
7042-04-04	1/4-18	1/4-19	31.91	20.70	18.00	•		•	
7042-04-06	1/4-18	3/8-19	36.90	25.50	24.00	•			
7042-04-08	1/4-18	1/2-14	24.80	10.00	26.00	•			
7042-06-04	3/8-18	1/4-19	38.30	26.60	24.00	•			
7042-06-06	3/8-18	3/8-19	35.22	23.70	23.80	•			
7042-06-08	3/8-18	1/2-14	42.50	25.70	26.00	•			
7042-08-08	1/2-14	1/2-14	44.30	27.10	26.00	•			
NEW 7042-08-12						•			
7042-12-12	3/4-12	3/4-12	56.52	37.44	33.00	•			
7042-16-16	1-11 1/2	1-11	55.25	36.30	41.30	•			
NEW 7042-16-20						•			
7042-20-16	1 1/4-11 1/2	1-11	50.00	27.90	50.80	•			
7042-20-20	1 1/4-11 1/2	1 1/4-11	62.90	39.80	50.85	•			
NEW 7042-20-24						•			
7042-24-20	1 1/2-11 1/2	1 1/4-11	60.70	37.90	57.00	•			
7042-24-24	1 1/2-11 1/2	1 1/2-11	60.20	38.40	57.20	•			
7042-32-32	2-11 1/2	2-11	61.80	35.30	69.70	•			

FP-MM Metric 7045 Series

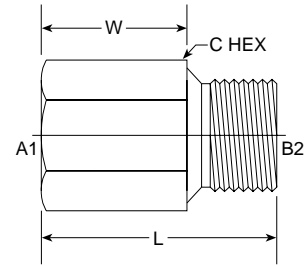

PART NO. SIZE	A1 FP	B2 MM	L LGTH M.M.	W WIDTH M.M.	C HEX M.M.	Standard Material From Stock			
						S	FG	SS	B
NEW 7045-02-06						•			
NEW 7045-02-14						•			
NEW 7045-02-16						•			
NEW 7045-02-18						•			
NEW 7045-02-20						•			
7045-04-10	1/4-18	10X1.0	32.75	21.95	19.05	•			
7045-04-12	1/4-18	12X1.5	33.22	21.85	19.06	•			
7045-02-10	1/8-27	10 x 1.0	29.90	20.00	14.20	•			
7045-04-14	1/4-18	14 x 1.5	35.00	25.00	19.00	•			
7045-06-16	3/8-18	16X1.5	38.50	27.20	22.30	•			
NEW 7045-06-18						•			
NEW 7045-06-20						•			
7045-08-16	1/2-14	16 x 1.5	42.40	29.70	28.60	•			
7045-08-18	1/2-14	18 x 1.5	42.90	28.90	28.50	•			
7045-08-22	1/2-14	22 x 1.5	45.00	28.50	29.00	•			
7045-12-26	3/4-14	26 x 1.5	45.60	26.90	35.00	•			
7045-12-27	3/4-14	27 x 2.0	45.70	26.70	35.00	•			
7045-16-33	1-11 1/2	33 x 2.0	50.10	30.30	42.00	•			
NEW 7045-16-42						•			

International Fittings

MORB-MBSPP 7062 Series

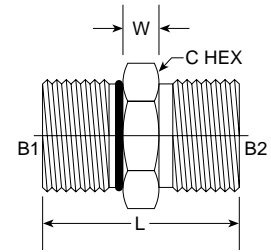

PART NO. SIZE	B1 SAE	B2 BSPP	L LGTH M.M.	W WIDTH M.M.	C HEX M.M.	Standard Material From Stock			
						S	FG	SS	B
7062-03-04	3/8-27	1/4-19	25.30	6.50	18	•			
7062-04-04	7/16-20	1/4-19	27.20	6.50	18	•			
7062-04-06	7/16-20	3/8-19	28.70	6.60	24	•			
7062-05-04	1/2-20	1/4-19	28.10	7.50	18	•			
7062-06-04	9/16-18	1/4-19	27.50	6.70	18	•			
7062-06-06	9/16-18	3/8-19	28.40	5.50	24	•			
7062-06-08	9/16-18	1/2-14	32.90	8.00	26	•			
7062-08-06	3/4-16	3/8-19	31.80	7.50	24	•			
7062-08-08	3/4-16	1/2-14	34.00	7.60	26	•			
7062-08-12	3/4-16	3/4-14	37.20	7.50	33	•			
7062-10-06	7/8-14	3/8-19	33.70	7.80	26	•			
7062-10-08	7/8-14	1/2-14	35.30	7.70	26	•			
7062-12-08	1 1/16-12	1/2-14	39.40	9.30	32	•			
7062-12-12	1 1/16-12	3/4-14	43.80	9.50	34	•			
7062-12-16	1 1/16-12	1-11	44.50	10.00	43	•			
7062-16-12	1 5/16-12	3/4-14	44.10	10.00	38	•			
7062-16-16	1 5/16-12	1-11	46.15	11.00	42.40	•			
7062-20-20	1 5/8-12	1 1/4-11	48.40	12.50	52	•			
NEW 7062-24-24						•			

MJ-MBSPT 45° Elbow 7100 Series

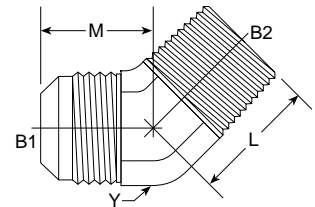

PART NO. SIZE	B1 JIC	B2 BSPT	L LGTH M.M.	M LGTH M.M.	Y FLATS M.M.	Standard Material From Stock			
						S	FG	SS	B
7100-04-04	7/16-20	1/4-19	21.50	21.00	14		•		
7100-06-04	9/16-18	1/4-19	21.50	21.00	14	•	•		
7100-06-06	9/16-18	3/8-19	24.00	22.00	19	•	•		
7100-08-06	3/4-16	3/8-19	24.00	25.00	19	•	•		
7100-08-08	3/4-16	1/2-14	30.00	25.00	22	•	•		
7100-10-08	7/8-14	1/2-14	29.50	28.00	22	•	•		
7100-12-12	1 1/16-12	3/4-14	30.50	32.50	27	•	•		
7100-16-16	1 5/16-12	1-11	37.50	37.00	33		•		

MJ-MBSPPADJ 45° Elbow 7102-NWO Series

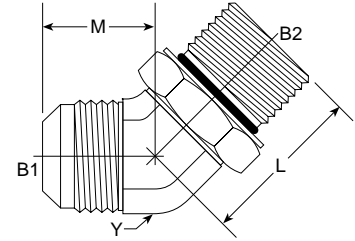

PART NO. SIZE	B1 JIC	B2 BSPP	L LGTH M.M.	M LGTH M.M.	Y FLATS M.M.	Standard Material From Stock			
						S	FG	SS	B
7102-04-04-NWO	7/16-20	1/4-19	29.00	21.00	11		•		
NEW 7102-06-04-NWO							•		
7102-06-06-NWO	9/16-18	3/8-19	33.00	22.00	14		•		
NEW 7102-08-06-NWO							•		
7102-08-08-NWO	3/4-16	1/2-14	38.50	25.50	19		•		
7102-12-12-NWO	1 1/16-12	3/4-14	44.00	32.50	27		•		
7102-16-16-NWO	1 5/16-12	1-11	47.00	37.00	33		•		
7102-20-20-NWO	1 5/8-12	1 1/4-11	48.50	40.50	41		•		

MJ-MBSPT 90° Elbow 7200 Series

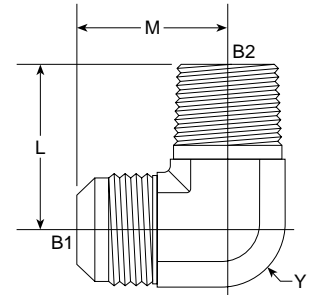

PART NO. SIZE	B1 JIC	B2 BSPT	L LGTH M.M.	M LGTH M.M.	Y FLATS M.M.	Standard Material From Stock			
						S	FG	SS	B
7200-04-02	7/16-20	1/8-28	20.55	23.55	11.50		•		
7200-04-04	7/16-20	1/4-19	27.50	27.00	14		•		
7200-06-04	9/16-18	1/4-19	27.50	27.00	14		•		
7200-06-06	9/16-18	3/8-19	31.00	28.50	19		•		
7200-08-06	3/4-16	3/8-19	31.00	31.50	19		•		
7200-08-08	3/4-16	1/2-14	37.00	24.00	22		•		
7200-12-12	1 1/16-12	3/4-14	40.50	42.00	27		•		
7200-16-16	1 5/16-12	1-11	50.00	46.00	33		•		
7200-20-20	1 5/8-12	1 1/4-11	60.00	52.00	41		•		

International Fittings

MJ-MBSPPADJ 90° Elbow 7202-NWO Series

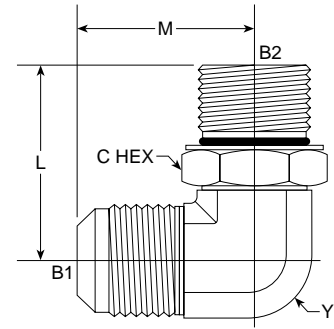

PART NO. SIZE	B1 JIC	B2 BSPP	L LGTH M.M.	M LGTH M.M.	C HEX M.M.	Y FLATS M.M.	Standard Material From Stock				
							S	FG	SS	B	
<i>NEW</i> 7202-04-02-NWO								•			
7202-04-04-NWO	7/16-20	1/4-19	31.50	27.00	19.50	11		•			
7202-05-04-NWO	1/2-20	1/4-19	31.40	27.40	19.00	14.28		•			
7202-06-04-NWO	9/16-18	1/4-19	36.50	28.50	19.50	14		•			
7202-06-06-NWO	9/16-18	3/8-19	36.50	28.50	24.00	14		•			
7202-06-08-NWO	9/16-18	1/2-14	43.00	31.00	28.50	19		•			
7202-08-06-NWO	3/4-16	3/8-19	36.50	31.50	24.00	19		•			
7202-08-08-NWO	3/4-16	1/2-14	43.00	34.00	28.50	19		•			
<i>NEW</i> 7202-08-12-NWO								•			
7202-10-08-NWO	7/8-14	1/2-14	43.00	36.50	28.50	22		•			
7202-10-12-NWO	7/8-14	3/4-14	49.00	39.50	35.00	22		•			
<i>NEW</i> 7202-12-08-NWO								•			
7202-12-12-NWO	1 1/16-12	3/4-14	49.00	42.00	35.00	27		•			
7202-12-16-NWO	1 1/16-12	1-11	52.70	44.50	41.00	33.50		•			
7202-16-12-NWO	1 5/16-12	3/4-14	52.52	46.20	36.00	34.00		•			
7202-16-16-NWO	1 5/16-12	1-11	52.00	46.00	43.00	33		•			
<i>NEW</i> 7202-16-20-NWO								•			
7202-20-20-NWO	1 5/8-12	1 1/4-11	57.00	52.00	52.50	41		•			
7202-24-24-NWO	1 1/2-12	1 1/2-12	61.70	59.00	60.00	48.00		•			

MJ-FBSPPS 90° Elbow 7204 Series

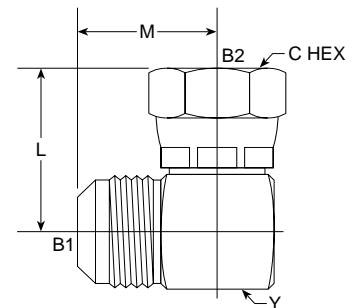

PART NO. SIZE	B1 JIC	B2 BSPP	L LGTH M.M.	M LGTH M.M.	C HEX M.M.	Y FLATS M.M.	Standard Material From Stock				
							S	FG	SS	B	
<i>NEW</i> 7204-06-06								•			
7204-08-08	3/4-16	1/2-14	25.00	33	25.40	22.23		•			
7204-12-12	1 1/16-12	1 1/16-12	27.80	41	31.75	33.33		•			

MJ-MMADJ 90° Elbow 7205-NWO Series

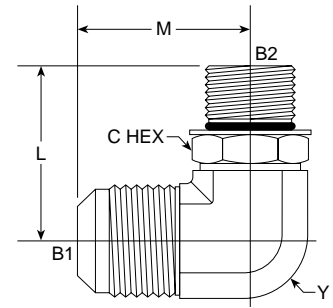

PART NO. SIZE	B1 JIC	B2 MM	L LGTH M.M.	M LGTH M.M.	C HEX M.M.	Y FLATS M.M.	Standard Material From Stock				
							S	FG	SS	B	
7205-04-10-NWO	7/16-20	10 x 1.0	27.50	22.50	14.50	11		•			
7205-04-12-NWO	7/16-20	12 x 1.5	31.50	27.00	17.50	14		•			
7205-04-14-NWO	7/16-20	14 x 1.5	32.00	27.00	19.50	14		•			
7205-06-14-NWO	9/16-18	14 x 1.5	32.50	27.00	19.50	14		•			
7205-08-16-NWO	3/4-16	16 x 1.5	36.50	31.50	22.50	19		•			
7205-08-18-NWO	3/4-16	18 x 1.5	39.50	31.50	24.50	19		•			
7205-10-18-NWO	7/8-14	18 x 1.5	41.50	36.50	24.50	22		•			
7205-10-20-NWO	7/8-14	20 x 1.5	43.00	36.50	27.50	23		•			
7205-10-22-NWO	7/8-14	22 x 1.5	43.00	36.50	27.50	22		•			
NEW 7205-12-22-NWO								•			
7205-12-27-NWO	1 1/16-12	27 x 2.0	51.50	42.00	32.50	27		•			
7205-12-33-NWO	1 1/16-12	33 x 2.0	52.00	43.00	52.00	33		•			
7205-16-33-NWO	1 5/16-12	33 x 2.0	55.00	46.00	41.50	33		•			

FJS-MBSPT 90° Elbow 7220 Series

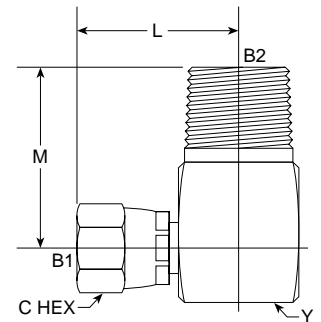

PART NO. SIZE	B1 JIC	B2 BSPP	L LGTH M.M.	M LGTH M.M.	C HEX M.M.	Y FLATS M.M.	Standard Material From Stock				
							S	FG	SS	B	
7220-06-08	9/16-18	1/2-14	31.75	37	18	22.23	•				

International Fittings

FJS-MBSPP 90° Elbow 7222 Series

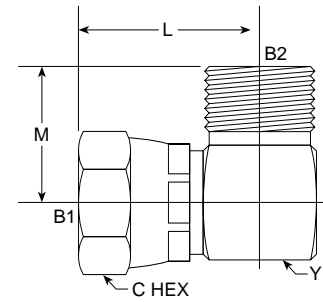

PART NO. SIZE	B1 JIC	B2 BSPP	L LGTH M.M.	M LGTH M.M.	C HEX M.M.	Y FLATS M.M.	Standard Material From Stock			
							S	FG	SS	B
7222-04-04	7/16-20	1/4-19	25	25	14	16	•			
7222-06-06	9/16-18	3/8-19	28.00	29.40	17.46	19.00	•			
7222-08-08	3/4-16	1/2-14	35.30	35.00	22.22	22.22	•			
7222-12-12	1 1/16-12	3/4-14	44.00	37.30	32.00	28.60	•			

PART NO. SIZE	B1 JIS	L LGTH M.M.	C HEX M.M.	Standard Material From Stock			
				S	FG	SS	B
7588-P-02	1/8-27	19.65	14.28	•			
7588-P-04	1/4-19	23.80	19.05	•			
7588-P-06	3/8-19	23.80	23.80	•			
7588-P-08	1/2-14	28.35	25.60	•			
7588-P-12	3/4-14	36.20	31.75	•			
7588-P-16	1-11	33.15	36.00	•			

MJIS Plug 7588-P Series

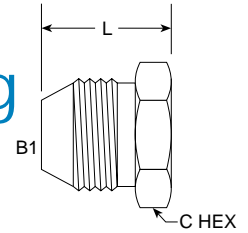

PART NO. SIZE	B1 MK	L LGTH M.M.	C HEX M.M.	Standard Material From Stock			
				S	FG	SS	B
7599-P-14	14 x 1.5	22.90	19.00	•			
7599-P-18	18 x 1.5	24.70	24	•			
7599-P-22	22 x 1.5	31.70	27.00	•			
7599-P-24	24 x 1.5	32.50	31.90	•			
7599-P-30	30 x 2.0	37.00	36.00	•			
7599-P-33	33 x 1.5	44.00	42	•			

Komatsu MK Plug 7599-P Series

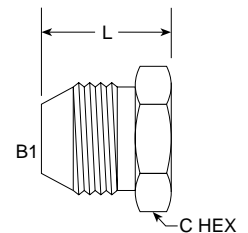

PART NO. SIZE	B1 JIS	L LGTH M.M.	C HEX M.M.	Standard Material From Stock			
				S	FG	SS	B
7688-C-02	1/8-28	17.88	15.87	•			
7688-C-04	1/4-19	22	19.05	•			
7688-C-06	3/8-19	22.4	22.22	•			
7688-C-08	1/2-14	27.4	26.99	•			
7688-C-12	3/4-14	31.5	31.75	•			
7688-C-16	1-11	28.55	38.20	•			

FJIS Cap 7688-C Series

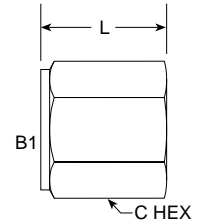

PART NO. SIZE	B1 FK	L LGTH M.M.	C HEX M.M.	Standard Material From Stock			
				S	FG	SS	B
7699-C-14	14 x 1.5	19.98	18.00	•			
7699-C-18	18 x 1.5	23.80	24.00	•			
7699-C-22	22 x 1.5	28.10	26.00	•			
NEW 7699-C-24				•			
7699-C-30	30 x 1.5	29.90	41.00	•			
7699-C-33	33 x 1.5	39.90	41.20	•			

Komatsu FK Cap 7699-C Series

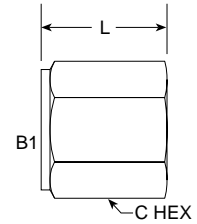

Metric MM-MM Nipple 8055 Series

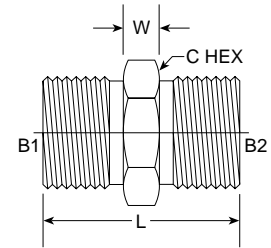

PART NO. SIZE	B1 MM	B2 MM	L LGTH M.M.	W WIDTH M.M.	C HEX M.M.	Standard Material From Stock			
						S	FG	SS	B
NEW 8055-16-16	16 x 1.5	16 x 1.5	27	7	17	•			
NEW 8055-18-18						•			
8055-20-20						•			

MJIS-MBSPT Union 8080 Series

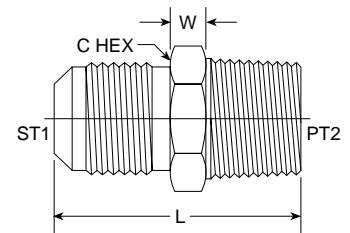

PART NO. SIZE	B1 JIS	B2 JIS	L LGTH M.M.	C HEX M.M.	Standard Material From Stock			
					S	FG	SS	B
NEW 8080-04-04								
NEW 8080-04-06								
NEW 8080-06-04								
NEW 8080-06-06								
NEW 8080-08-06								
NEW 8080-08-08								
NEW 8080-12-12								
NEW 8080-16-16								

International Fittings

MJIS-MJIS Union 8088 Series

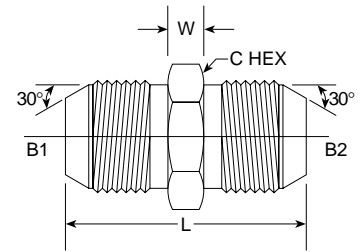

PART NO. SIZE	B1 JIS	B2 JIS	L LGTH M.M.	C HEX M.M.	Standard Material From Stock			
					S	FG	SS	B
8088-04-04	1/4-19	1/4-19	38.00	20	•			
8088-06-06	3/8-19	3/8-19	39.70	24	•			
8088-08-08	1/2-14	1/2-14	47.00	26	•			
8088-12-12	3/4-14	3/4-14	55.90	32	•			

MJIS-MBSPT Union 8180 Series

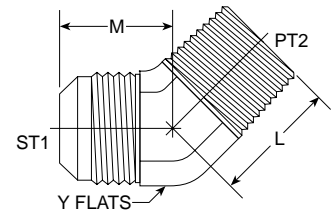

PART NO. SIZE	ST1 JIS	PT2 JIS	L LGTH M.M.	M LGTH M.M.	Y FLATS M.M.	Standard Material From Stock			
						S	FG	SS	B
<i>NEW</i> 8180-04-04									
<i>NEW</i> 8180-06-06									
<i>NEW</i> 8180-08-08									
<i>NEW</i> 8180-12-12									
<i>NEW</i> 8180-16-16									

MJIS-MBSPT Union 8280 Series

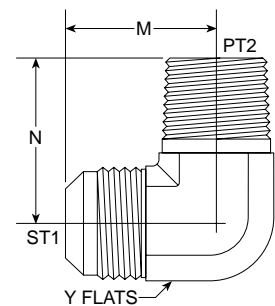

PART NO. SIZE	ST1 JIS	PT2 JIS	N LGTH M.M.	C HEX M.M.	Y FLATS M.M.	Standard Material From Stock			
						S	FG	SS	B
<i>NEW</i> 8280-04-04									
<i>NEW</i> 8280-06-06									
<i>NEW</i> 8280-08-08									
<i>NEW</i> 8280-12-12									
<i>NEW</i> 8280-16-16									

Metric MM Hollow Hex Plug 8555-H Series

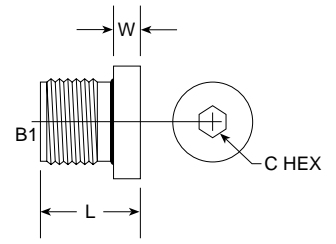

PART NO. SIZE	B1 MM	L LGTH M.M.	W WIDTH M.M.	C HEX M.M.	Standard Material From Stock			
					S	FG	SS	B
NEW 8555-H10-0					•			
NEW 8555-H12-0					•			
NEW 8555-H14-0					•			
NEW 8555-H16-0					•			
8555-H18-0	18 x 1.5	17.00	5	8	•			
8555-H22-0	22 x 1.5	19.10	5	10	•			
NEW 8555-H24-0					•			
NEW 8555-H26-0					•			

Metric MM Plug 1.5 Pitch 8555-P Series

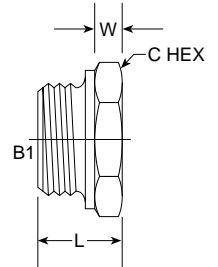

PART NO. SIZE	B1 MM	L LGTH M.M.	W WIDTH M.M.	C HEX M.M.	Standard Material From Stock			
					S	FG	SS	B
8555-P-10	10 x 1.0	12.00	4	11	•			
8555-P-12	12 x 1.5	16.70	7	18	•			
8555-P-14	14 x 1.5	17.40	8	19	•			
8555-P-16	14 x 1.5	16.40	8	22	•			
8555-P-18	18 x 1.5	17.10	8	23	•			
8555-P-20	20 x 1.5	16.80	8	26	•			
8555-P-24	24 x 1.5	17.60	8	33	•			
8555-P-26	26 x 1.5	17.60	8	33	•			
NEW 8555-P-36					•			

PART NO. SIZE	I.D. M.M.	O.D. M.M.	Standard Material From Stock			
			S	FG	SS	B
8800-06	6	10	•			
8800-08	8	13	•			
8800-10	10	18	•			
8800-12	12	20	•			
8800-14	14	22	•			
8800-16	16	24	•			
8800-18	18	26	•			
8800-20	20	28	•			
8800-22	22	30	•			
NEW 8800-24			•			
8800-26	26	35	•			
8800-27	27	36	•			
8800-30	30	39	•			
8800-33	33	43	•			
8800-36	36	46	•			
8800-42	42	53	•			
8800-52	52	64	•			

Metric Bonded Seal 8800 Series

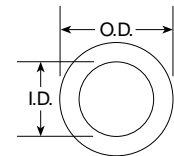

For metric threads.

International Fittings

MBSPT-MBSPT Nipple 9000 Series

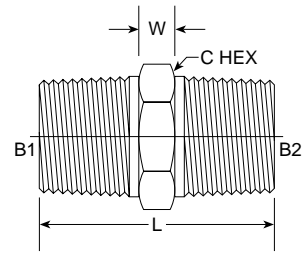

PART NO. SIZE	B1 BSPT	B2 BSPT	L LGTH M.M.	W LGTH M.M.	C HEX M.M.	Standard Material From Stock			
						S	FG	SS	B
9000-02-02	1/8-27	1/8-28	27.30	5	11.11	•			
9000-04-02	1/4-19	1/8-28	33.10	8	15.00	•			
9000-04-04	1/4-19	1/4-19	40.50	8	14.28	•			
9000-06-02	3/8-19	1/8-28	36.40	8	17.46	•			
9000-06-04	3/8-19	1/4-19	40.60	8	17.46	•			
9000-06-06	3/8-19	3/8-19	42.40	8	17.40	•			
9000-08-04	1/2-14	1/4-19	46.30	8	22.00	•			
9000-08-06	1/2-14	3/8-19	46.70	8	22.22	•			
9000-08-08	1/2-14	1/2-14	52.20	8	22.22	•			
9000-10-10	5/8-14	5/8-14	53.70	9	26.00	•			
9000-12-08	3/4-14	1/2-14	54.80	11	28.00	•			
9000-12-12	3/4-14	3/4-14	55.10	11	28.00	•			
9000-16-12	1-11	3/4-14	62.10	12.35	35.00	•			
9000-16-16	1-11	1-11	66.90	12	34.92	•			
9000-20-20	1 1/4-11	1 1/4-11	69.10	13	47.00	•			
9000-24-24	1 1/2-11	1 1/2-11	73.40	14	52.00	•			
9000-32-32	2-11	2-11	73.80	14	70.00	•			

MBSPT-FBSPT Bushing 9001 Series

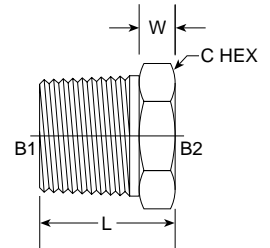

PART NO. SIZE	B1 BSPT	B2 BSPT	L LGTH M.M.	W WIDTH M.M.	C HEX M.M.	Standard Material From Stock			
						S	FG	SS	B
9001-04-02	1/4-19	1/8-28	23.80	8	14.28	•			
9001-06-04	3/8-19	1/4-19	25.85	8.57	17.46	•			
9001-08-06	1/2-14	3/8-19	25.30	6	22.02	•			
9001-12-08	3/4-14	1/2-14	31.90	10	28.00	•			
NEW 9001-16-12						•			
9001-20-16	1 1/4-11	1-11	40.60	12.70	47.22	•			

MBSPT-FBSPT 90° Elbow 9002 Series

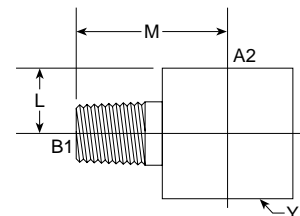

PART NO. SIZE	B1 BSPT	A2 BSPT	L LGTH M.M.	M LGTH M.M.	Y FLATS M.M.	Standard Material From Stock			
						S	FG	SS	B
9002-02-02	1/8-28	1/8-28	8	19	17.46	•			

MBSPP-MBSPT Straight 9020 Series

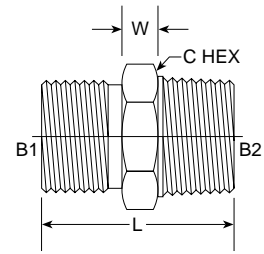

PART NO. SIZE	B1 BSPP	B2 BSPT	L LGTH M.M.	W WIDTH M.M.	C HEX M.M.	Standard Material From Stock			
						S	FG	SS	B
NEW 9020-04-04	3/8-19	1/4-19	37.10	8	24	•			
NEW 9020-04-06						•			
9020-06-04						•			
NEW 9020-06-06	1-11	1-11	59.30	11.30	42.35	•			
9020-16-16						•			
NEW 9020-20-20						•			

MBSPP-MBSPP Nipple 9022 Series

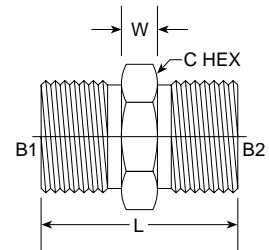

PART NO. SIZE	B1 BSPP	B2 BSPP	L LGTH M.M.	W WIDTH M.M.	C HEX M.M.	Standard Material From Stock			
						S	FG	SS	B
9022-02-02	1/8-28	1/2-28	27.20	5	15	•			
9022-04-02	1/4-19	1/8-28	29.40	6.25	18.00	•			
9022-04-04	1/4-19	1/4-19	30.70	7	18	•			
9022-06-04	3/8-19	1/4-19	32.10	7	24	•			
9022-06-06	3/8-19	3/8-19	32.30	6	24	•			
9022-08-04	1/2-14	1/4-19	32.80	7	26	•			
9022-08-06	1/2-14	3/8-19	34.80	7	26	•			
9022-08-08	1/2-14	1/2-14	36.80	7	26	•			
9022-10-06	5/8-14	3/8-19	37.80	7.30	28.00	•			
9022-10-08	5/8-14	1/2-14	39.80	7	28	•			
9022-10-10	5/8-14	5/8-14	42.20	7	28	•			
9022-12-06	3/4-14	3/8-19	40.00	8	33	•			
9022-12-08	3/4-14	1/2-14	41.80	8.00	33.00	•			
9022-12-10	3/4-14	5/8-14	45.50	9	33	•			
9022-12-12	3/4-14	3/4-14	45.90	8	33	•			
9022-16-08	1-11	1/2-14	45.30	9.50	42.40	•			
9022-16-12	1-11	3/4-14	49.15	10.05	42.50	•			
9022-16-16	1-11	1-11	49.70	9.50	42.40	•			
9022-20-16	1 1/4-11	1-11	50.80	10.30	52.00	•			
9022-20-20	1 1/4-11	1 1/4-11	51.30	11	52	•			
NEW 9022-24-20						•			
9022-24-24	1 1/2-11	1 1/2-11	54.60	12	57	•			
9022-32-24	2-11	1 1/2-11	60.00	13	70	•			
9022-32-32	2 1/2-11	2 1/2-11	63.60	12.80	70.20	•			

International Fittings

MBSPP-FBSPP 9023 Series

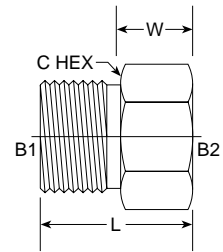

PART NO. SIZE	B1 BSPP	B2 BSPP	L LGTH M.M.	W WIDTH M.M.	C HEX M.M.	Standard Material From Stock			
						S	FG	SS	B
9023-04-06	1/4-19	3/8-19	35.20	23.70	23.34	•			
9023-06-04	3/8-19	1/4-19	36.60	23.40	24	•			
9023-06-06	3/8-19	3/8-19	36.95	23.60	23.35	•			
9023-06-08	3/8-19	1/2-14	40.20	27.25	25.70	•			
9023-08-04	1/2-14	1/4-19	24.65	9.70	25.70	•			
9023-08-06	1/2-14	3/8-19	42.60	27.75	25.70	•			
NEW 9023-12-06						•			
9023-12-08	3/4-14	1/2-14	52.40	33.50	33	•			
9023-12-12	3/4-12	3/4-012	52.40	33.55	33.00	•			
9023-16-08	1-11	1/2-14	32.30	12.20	42.50	•			
9023-32-16	2-11	1-11	43.10	18.00	70	•			

MBSPP-FBSPPS 9024 Series

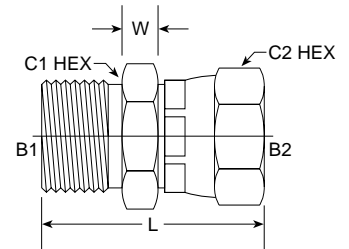

PART NO. SIZE	B1 BSPP	B2 BSPP	L LGTH M.M.	W WIDTH M.M.	C1 HEX M.M.	C2 HEX M.M.	Standard Material From Stock			
							S	FG	SS	B
9024-02-02	1/8-28	1/8-28	34.50	8	16	16	•			
9024-04-04	1/4-19	1/4-19	35.20	8	18	18	•			
9024-06-06	3/8-19	3/8-19	41.60	8	24	22	•			
9024-08-08	1/2-14	1/2-14	47.10	10	26	26	•			
NEW 9024-08-12							•			
NEW 9024-10-10							•			
9024-12-08	3/4-14	1/2-14	51.10	11	33	26	•			
9024-12-12	3/4-14	3/4-14	53.30	11	33	33	•			
9024-16-16	1-11	1-11	58.70	13	43	38	•			
NEW 9024-20-20							•			

Metric MBSPP-MM Nipple 9025 Series

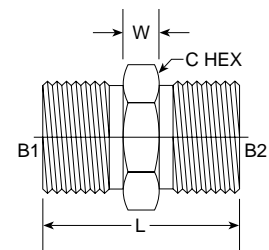

PART NO. SIZE	B1 BSPP	B2 MM	L LGTH M.M.	W WIDTH M.M.	C HEX M.M.	Standard Material From Stock			
						S	FG	SS	B
9025-04-14	1/4-19	14 x 1.5	28.80	6	19	•			
9025-06-12	3/8-19	12 x 1.5	32.20	7	24	•			
9025-06-16	3/8-19	16 x 1.5	33.00	7.05	23.35	•			
9025-06-18	3/8-19	18 x 1.5	33.60	7.05	23.35	•			
NEW 9025-06-20						•			
NEW 9025-08-18						•			
NEW 9025-12-18						•			
9025-12-20	3/4-14	20 x 1.5	40.70	9	33	•			
NEW 9025-12-22						•			

FBSP- FBSP Coupling 9033 Series

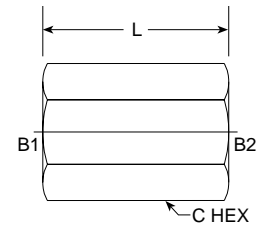

PART NO. SIZE	B1 BSPP	B2 BSPP	L LGTH M.M.	C HEX M.M.	Standard Material From Stock			
					S	FG	SS	B
9033-02-02	1/8-28	1/8-28	25.40	15	•			
9033-04-02	1/4-19	1/8-28	25.60	18.00	•			
9033-04-04	1/4-19	1/4-19	25.40	18	•			
9033-06-04	3/8-19	1/4-19	28.60	24	•			
9033-06-06	3/8-19	3/8-19	28.70	24	•			
9033-08-06	1/2-14	3/8-19	32.30	26	•			
9033-08-08	1/2-14	1/2-14	32.50	26	•			
9033-10-10	5/8-14	5/8-14	38.20	28	•			
9033-12-12	3/4-14	3/4-14	42.80	33	•			
9033-16-16	1-11	1-11	50.80	42.42	•			
9033-20-20	1 1/4-11	1 1/4-11	55.80	52	•			
9033-32-32	2 1/2-11	2 1/2-11	69.85	70.10	•			

MBSPP- FBSPPS Swept 45° 9124 Series

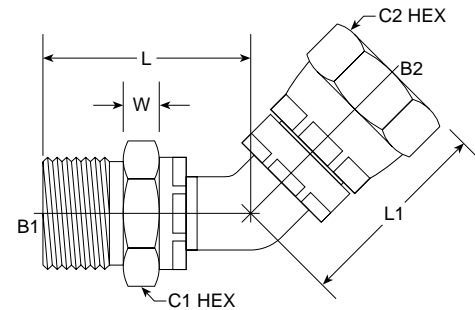

PART NO. SIZE	B1 BSPP	B2 BSPP	L LGTH M.M.	L1 LGTH M.M.	W WIDTH M.M.	C1 HEX M.M.	C2 HEX M.M.	Standard Material From Stock			
								S	FG	SS	B
NEW 9124-06-06								•			
9124-08-08	1/2-14	1/2-14	38	40	9	26	26	•			

MBSPP- MBSPP 90° 9222 Series

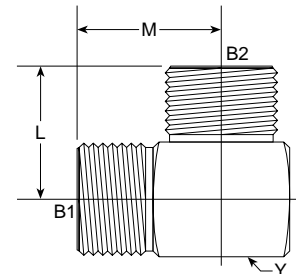

PART NO. SIZE	B1 BSPP	B2 BSPP	L LGTH M.M.	M LGTH M.M.	Y FLATS M.M.	Standard Material From Stock			
						S	FG	SS	B
9222-04-04	1/4-19	1/4-19	25.20	26.10	15.87	•			
9222-06-06	3/8-19	3/8-19	28.25	30.60	19.00	•			
9222-08-08	1/2-14	1/2-14	34.00	33.40	22.20	•			

International Fittings

MBSPP-FBSPPS 90° 9224 Series

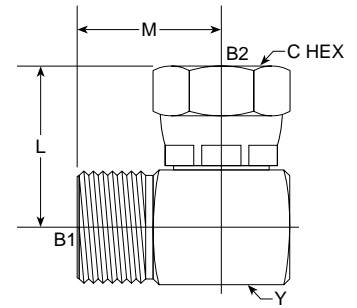

PART NO. SIZE	B1 BSPP	B2 BSPP	L LGTH M.M.	M LGTH M.M.	C HEX M.M.	Y FLATS M.M.	Standard Material From Stock			
							S	FG	SS	B
NEW 9224-02-02							•			
9224-04-04	1/4-19	1/4-19	24	24	18	16	•			
9224-06-06	3/8-19	3/8-19	30	28	22	19	•			
9224-08-08	1/2-14	1/2-14	32	33	26	22	•			
9224-12-12	3/4-14	3/4-14	40.00	36.50	33.00	28.60	•			
9224-16-16	1-11	1-11	44.50	44.80	37.60	35.00	•			
9224-24-24	1 1/2-11	1 1/2-11	59.30	61.60	56.46	50.71	•			

MBSPP-FBSPPS 90° Long 9224-L Series

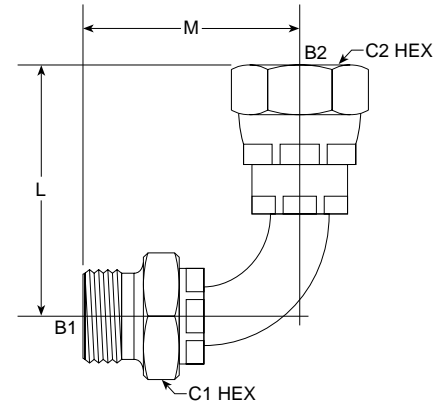

PART NO. SIZE	B1 BSPP	B2 BSPP	L LGTH M.M.	M LGTH M.M.	C1 HEX M.M.	C2 HEX M.M.	Standard Material From Stock			
							S	FG	SS	B
NEW 9224-L-08-08							•			
9224-L-12-12							•			
9224-L-16-16	1-11	1-11	75	72.00	43	38	•			
9224-L-24-24	1 1/2-11	1 1/2-11	104	100.00	57	57	•			

MBSPP-MBSPP-MBSPP Tee 9322 Series

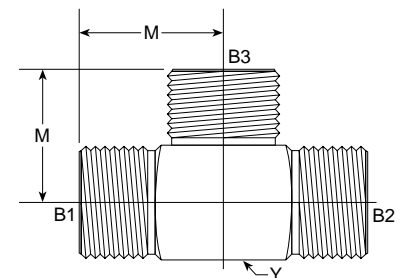

PART NO. SIZE	B1 BSPP	B2 BSPP	B3 BSPP	M LGTH M.M.	Y FLATS M.M.	Standard Material From Stock			
						S	FG	SS	B
9322-04-04-04	1/4-19	1/4-19	1/4-19	23.00	18.00	•			
9322-06-06-06	3/8-19	3/8-19	3/8-19	24.00	19.00	•			
9322-08-08-08	1/2-14	1/2-14	1/2-14	30.00	25.63	•			
9322-12-12-12	3/4-14	3/4-14	3/4-14	40.00	33.05	•			

FBSPP-FBSPP-FBSPP Tee 9344 Series

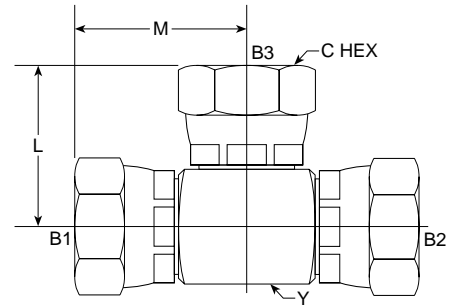

PART NO. SIZE	B1 BSPP	B2 BSPP	B3 BSPP	L LGTH M.M.	M LGTH M.M.	C HEX M.M.	Y FLATS M.M.	Standard Material From Stock				
								S	FG	SS	B	
9344-04-04-04	1/4-19	1/4-19	1/4-19	24	24	18	16	•				
9344-06-06-06	3/8-19	3/8-19	3/8-19	30	32	22	19	•				

MBSPT Plug 9500-P Series

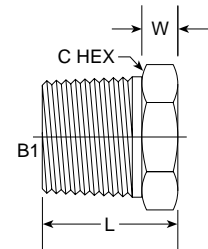

PART NO. SIZE	B1 BSPT	L LGTH M.M.	W WIDTH M.M.	C HEX M.M.	Standard Material From Stock			
					S	FG	SS	B
9500-P-02	1/8-28	17.12	5.70	11	•			
9500-P-04	1/4-19	20.00	8	16	•			
9500-P-06	3/8-19	25.40	8	18	•			
9500-P-08	1/2-14	30.00	8	22	•			
9500-P-10	5/8-14	31.10	9	26	•			
9500-P-12	3/4-14	32.60	10	28	•			
9500-P-16	1-11	39.50	12	35	•			
9500-P-20	1 1/4-11	40.70	13	48	•			
9500-P-24	1 1/2-11	43.60	14	57	•			
9500-P-32	2 1/2-11	46.40	16.40	70	•			

MBSPP Hollow Hex Plug 9522-H Series

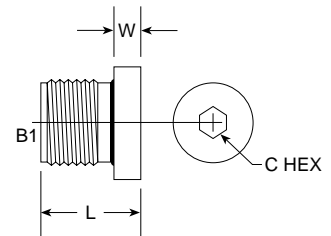

PART NO. SIZE	B1 BSPP	L LGTH M.M.	W WIDTH M.M.	C HEX M.M.	Standard Material From Stock			
					S	FG	SS	B
9522-H-02-0	1/2-28	12.10	4.20	5	•			
9522-H-04-0	1/4-19	16.60	5	6	•			
9522-H-06-0	3/8-19	17.00	5.00	8	•			
9522-H-08-0	1/2-14	19.00	5.20	10	•			
9522-H-12-0	3/4-14	21.20	6	12	•			

International Fittings

MBSPP Hex Plug 9522-P Series

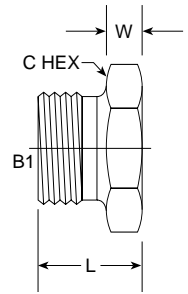

PART NO. SIZE	B1 BSPP	L LGTH M.M.	W WIDTH M.M.	C HEX M.M.	Standard Material From Stock			
					S	FG	SS	B
9522-P-02	1/8-28	15.50	5.00	15.00	•			
9522-P-04	1/4-19	17.00	7.00	18.00	•			
9522-P-06	3/8-19	18.50	7.00	24.00	•			
9522-P-08	1/2-14	20.00	8.00	26.00	•			
9522-P-10	5/8-14	26.70	9.00	28.00	•			
9522-P-12	3/4-14	22.80	9.00	33.00	•			
9522-P-16	1-11	26.00	10.00	43.00	•			
NEW 9522-P-20					•			
9522-P-24	1 1/2-11	34.00	12.60	56.40	•			
9522-P-32	2-11	44.80	17.80	70.00	•			
9522-P-48	3-11	41.90	16.50	94.80	•			

FBSPP Cap 9644-C Series

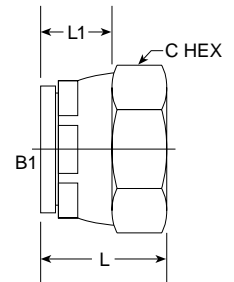

PART NO. SIZE	B1 BSPP	L LGTH M.M.	L1 LGTH M.M.	C HEX M.M.	Standard Material From Stock			
					S	FG	SS	B
9644-C-02	1/8-19	17	11	15	•			
9644-C-04	1/4-19	18	13	13	•			
9644-C-06	3/8-19	22	15	15	•			
9644-C-08	1/2-14	25	16	17	•			
9644-C-10	5/8-14	25	15	17	•			
9644-C-12	3/4-14	27	16	33	•			
9644-C-16	1-11	28.35	14.50	37.52	•			
9644-C-20	1 1/4-11	29.50	14.80	47.28	•			
9644-C-24	1 1/2-11	23	23	44	•			
9644-C-32	2 1/2-11	41.80	21.40	70.12	•			

MBSPP-MBSPP Bulkhead 9722-LN Series

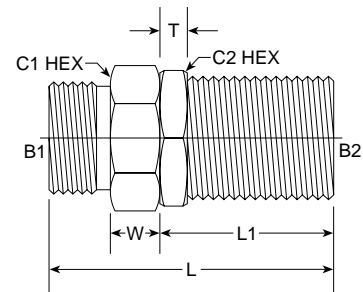

PART NO. SIZE	B1 BSPP	B2 BSPP	L LGTH M.M.	L1 LGTH M.M.	T WIDTH M.M.	W WIDTH M.M.	C1 HEX M.M.	C2 HEX M.M.	Standard Material From Stock			
									S	FG	SS	B
9722-04-04-LN	1/4-19	1/4-19	45.00	26.00	5.68	7.40	18.00	18.00	•			
9722-06-06-LN	3/8-19	3/8-19	50.00	28.00	5.50	9.00	23.40	23.40	•			
9722-08-08-LN	1/2-14	1/2-14	59.00	32.30	6.50	11.14	25.62	25.70	•			
9722-10-10-LN	5/8-14	5/8-14	61.50	33.50	6.50	10.30	28.00	28.00	•			
9722-12-12-LN	3/4-14	3/4-14	61.50	33.50	6.60	9.00	33.00	33.00	•			
NEW 9722-16-16-LN									•			

PART NO. SIZE	I.D.	O.D.	Standard Material From Stock			
			S	FG	SS	B
9900-02	0.408	0.625	•			
9900-04	0.540	0.809	•			
9900-06	0.682	0.937	•			
9900-08	0.850	1.125	•			
9900-10	0.925	1.250	•			
9900-12	1.062	1.375	•			
9900-16	1.338	1.687	•			
9900-20	1.699	2.063	•			
9900-24	1.910	2.310	•			
9900-32	2.389	2.875	•			

British Bonded Seal 9900 Series

For British threads.

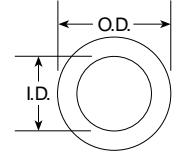

BSPB Locknut 9925 Series

For British threads.

PART NO. SIZE	I.D.	O.D.	Standard Material From Stock			
			S	FG	SS	B
NEW 9925-20			•			
NEW 9925-24			•			
NEW 9925-32			•			

